

COCRYSTALS OF SYMPLECTIC KASHIWARA-NAKASHIMA TABLEAUX, SYMPLECTIC WILLIS LIKE DIRECT WAY, VIRTUAL KEYS AND APPLICATIONS

OLGA AZENHAS AND JOÃO MIGUEL SANTOS

ABSTRACT. We attach a \mathfrak{sl}_2 crystal, called cocrystal, to a symplectic Kashiwara-Nakashima (KN) tableau, whose vertices are skew KN tableaux connected via the Lecouvey-Sheats symplectic *jeu de taquin*. These cocrystals contain all the needed information to compute right and left keys of a symplectic KN tableau. Motivated by Willis' direct way of computing type A right and left keys, we also give a way of computing symplectic, right and left, keys without the use of the symplectic *jeu de taquin*. On the other hand, we prove that Baker virtualization by folding A_{2n-1} into C_n commutes with dilatation of crystals. Thus we may alternatively utilize this Baker virtualization to embed a type C_n Demazure crystal, its opposite and atoms into A_{2n-1} ones. The right, respectively left keys of a KN tableau are thereby computed as A_{2n-1} semistandard tableaux and returned back via reverse Baker embedding to the C_n crystal as its right respectively left symplectic keys. In particular, Baker embedding also virtualizes the crystal of Lakshmibai-Seshadri paths as B_n -paths into the crystal of Lakshmibai-Seshadri paths as \mathfrak{S}_{2n} -paths. Lastly, as an application of our explicit symplectic right and left key maps, thanks to the isomorphism between Lakshmibai-Seshadri path and Kashiwara crystals we use, similarly to the $Gl(n, \mathbb{C})$ case, left and right key maps as a tool to test whether a symplectic KN tableau is *standard* on a Schubert or Richardson variety in the flag variety $Sp(2n, \mathbb{C})/B$, with B a Borel subgroup.

1. INTRODUCTION

Symplectic tableaux [27, 14, 26] provide the monomial weight generators for the characters of the symplectic Lie algebra $\mathfrak{sp}(2n, \mathbb{C})$. Given a partition $\lambda \in \mathbb{Z}_{\geq 0}^n$, symplectic Kashiwara-Nakashima (KN) tableaux of shape λ , on the alphabet $[\pm n]$ [26], a variation of De Concini tableaux in symplectic *standard* monomial theory [14], are endowed with a type C_n Kashiwara crystal structure $\mathfrak{B}(\lambda)$ compatible with a plactic monoid and sliding algorithms, studied by Lecouvey in terms of crystal isomorphisms [34].

Let $G = Sp(2n, \mathbb{C})$ be the symplectic group. Fix $H \subseteq B \subseteq G$, H a maximal torus, B a Borel subgroup, and let W be the associated Weyl group identified as a Coxeter group with B_n (hyperoctahedral group) with longest element $w_0 = -Id$. Let the Lie algebras of G , B and H be $\mathfrak{g} = \mathfrak{sp}(2n, \mathbb{C})$, \mathfrak{b} , a Borel subalgebra of \mathfrak{g} , and \mathfrak{h} , a Cartan subalgebra of \mathfrak{g} , respectively. Let $V(\lambda)$ be the irreducible G -module with highest weight λ . The Kashiwara crystal $\mathfrak{B}(\lambda)$ is a combinatorial skeleton for the G -module $V(\lambda)$. Another combinatorial skeleton is the Littelmann crystal of Lakshmibai-Seshadri (L-S) paths of shape λ , denoted $\mathbf{B}(\lambda)$, isomorphic to the Kashiwara crystal $\mathfrak{B}(\lambda)$. For $w \in W$, the Demazure module $V_w(\lambda) \subseteq V(\lambda)$ is the B -submodule defined $V_w(\lambda) = \mathcal{U}(\mathfrak{b}).V(\lambda)_{w\lambda}$, where $\mathcal{U}(\mathfrak{b})$ is the enveloping algebra of the Borel subalgebra \mathfrak{b} of \mathfrak{g} , and $V(\lambda)_{w\lambda}$ is the one dimensional weight space of $V(\lambda)$ with extremal weight $w\lambda$. The Demazure module $V_e(\lambda)$ is just one-dimensional generated by the highest weight vector of $V(\lambda)$ and $V_{w_0}(\lambda) = V(\lambda)$.

2000 *Mathematics Subject Classification.* 05E10, 05E05, 17B37, 14M15.

Key words and phrases. Kashiwara-Nakashima tableaux, symplectic keys, right and left key maps, Demazure crystals, Schubert varieties, crystal dilatation, Baker virtualization.

Key polynomials or Demazure characters are the characters of the Demazure modules $V_w(\lambda)$. Let $W\lambda$ be the orbit of λ with the induced Bruhat order, and $u, v \in W\lambda$. Kashiwara [22] and Littelmann [38] have shown that they can be obtained by summing the monomial weights over certain subsets $\mathfrak{B}_v = \mathfrak{B}_w(\lambda)$, $v = w\lambda \in W\lambda$, in the crystal $\mathfrak{B}(\lambda)$, called Demazure crystals. Demazure crystals \mathfrak{B}_v can be partitioned into Demazure crystal atoms, \mathfrak{B}_u , where $u \in W\lambda$ runs in the Bruhat interval $\lambda \leq u \leq v$ of $W\lambda$. Therefore the $\dim V_w(\lambda)$ is the cardinality of \mathfrak{B}_v , $v = w\lambda$.

Considering G/B the (full) flag variety, G is a semi-simple algebraic group over k closed algebraic field, where we fix $H \subseteq B \subseteq G$ and W its Weyl group equipped with the (strong) Bruhat order, with w_0 is the long element, we have also for any $w \in W$ the corresponding Schubert variety $X_w = \bigsqcup_{\tau \leq w} B\tau B/B \subseteq G/B$ where $G = \bigsqcup_{\tau \in W} B\tau B$ is the Bruhat decomposition of G . The Borel-Weil theorem provides a geometric interpretation of Demazure and opposite Demazure modules showing that they are in natural correspondence with Schubert respectively opposite Schubert varieties also compatible with restrictions and intersections. For any $\lambda \in \mathbb{Z}_{\geq 0}^n$ a partition, we have L_λ the line bundle on G/B and its restriction (denoted by the same symbol) to X_w . There is a G (resp. B)-module isomorphism between the dual module $V^*(\lambda)$ (resp. dual submodule $V_w^*(\lambda)$) of $V(\lambda)$ and the space of global sections (also called the zero degree cohomology of the sheaf of sections of a line bundle) $H^0(G/B, L_\lambda)$ (resp. $H^0(X_w, L_\lambda)$): $V^*(\lambda) = V(-w_0\lambda) \simeq H^0(G/B, L_\lambda)$, and $V_w^*(\lambda) = V(-w_0\lambda) \simeq H^0(X_w, L_\lambda)$. When $G = Sp(2n, \mathbb{C})$ it holds $V^*(\lambda) = V(w_0\lambda) \simeq H^0(G/B, L_\lambda)$, and $V_w^*(\lambda) = V(\lambda) \simeq H^0(X_w, L_\lambda)$. In particular, for $w = w_0$, respectively $w = e$, one has $X_{w_0} = G/B$, respectively $X_e = B$, and $V_{w_0}(\lambda) = V(\lambda)$, respectively $V_e(\lambda) = \{b_\lambda\}$. For any $\tau \leq w$ in W , $X_\tau \subseteq X_w$ and the restriction map $H^0(G/B, L_\lambda) \rightarrow H^0(X_\tau, L_\lambda)$ is surjective. Hence $V_\tau(\lambda) \subseteq V_w(\lambda)$. (We refer to [29, 31] and references therein.)

Kashiwara has constructed a specific \mathbb{C} -basis for the irreducible highest weight \mathfrak{g} -module $V(\lambda)$ via the quantized enveloping Lie algebra. More precisely, the specialization $q = 1$ in the Kashiwara lower global basis (= Lusztig canonical basis [39]) $\{G_\lambda(b) : b \in \mathfrak{B}(\lambda)\}$ [23] gives that aforesaid basis for $V(\lambda)$. We then may also conclude from [22, Proposition 3.2.3 (i), (4.1)] that the Kashiwara lower global basis at $q = 1$ restricts to Demazure and opposite Demazure modules of $V(\lambda)$. More precisely, given w in the Weyl group W $\{G_\lambda(b) : b \in \mathfrak{B}_w(\lambda)\}$ at $q = 1$ gives a basis for the Demazure module $V_w(\lambda)$ and $\{G_\lambda(b) : b \in \mathfrak{B}^w(\lambda)\}$ at $q = 1$ gives a basis for the opposite Demazure module $V^w(\lambda)$. More generally, the restriction of the Global/Canonical basis to vectors labelled by vertices in a Demazure crystal of a highest weight crystal gives the Global/canonical basis of the corresponding Demazure module.

From a geometric vein, De Concini [14] constructed in the symplectic case bases indexed by *standard* symplectic tableaux, that is symplectic tableaux in $\mathfrak{B}(\lambda)$ indexing bases for the homogeneous components of the coordinate rings of the isotropic flag varieties $Sp(2n, \mathbb{C})/B$ and thanks to the Borel-Weil theorem they are bases for the irreducible representations of $Sp(2n, \mathbb{C})$. The symplectic tableaux in $\mathfrak{B}_w(\lambda)$ ($\mathfrak{B}^w(\lambda)$) index a basis for the coordinate ring of the Schubert variety X_w and, by the Weil-Borel theorem, a basis for the corresponding Demazure modules [29, 31, Theorem A.4.0.1, Corollary A.4.0.2]. These bases are called *standard* monomial bases. For the general case, G a semisimple algebraic group, there are constructions using the crystal of L-S paths, and we refer to [29] (also here §3.6.4). Despite of these bases being indexed by the same combinatorial objects, the relation between Global basis at $q = 1$ and *standard* monomial bases is not yet well understood in full generality.

Keys in type A_{n-1} have its origin in the $GL(n, \mathbb{C})$ *standard* bases to detect the semistandard tableaux which are *standard* on a Schubert variety. (See [43] for an application of keys within *standard* monomial theory.) In type A_{n-1} , Lascoux and Schützenberger characterized key tableaux as semistandard Young tableaux (SSYT) with nested columns [33, Definition 2.9], and have used the *jeu de taquin* to define the *right key respectively left key maps* which sends a SSYT T to a key tableau pair $(K^+(T), K^-(T))$, called the *right key* respectively *left key* of T . A tableau is a key if and only if it is equal to its right

and left key. In each Demazure crystal atom there exists exactly one key tableau and the right key map detects the Demazure crystal atom that contains a given SSYT [33, Theorem 3.8]. By direct inspection of a Young tableau, Willis [51] has given an alternative algorithm to compute the right (respect. left) key of a semistandard tableau that does not require the use of *jeu de taquin*. Other methods to compute the type A right or left key maps includes the alcove path model [36], semi-skyline augmented fillings [42], coloured vertex models [9] or [40]. For a complete overview in type A , see [9] and the references therein.

In type C_n , symplectic key tableaux are characterized in [3, 45, 44, 20]. They are the unique tableaux in $\mathfrak{B}(\lambda)$ whose weight is in $W\lambda$, and, for each one, there is exactly one Demazure crystal atom indexed by the corresponding weight. Using the Lecouvey-Sheats symplectic *jeu de taquin*, a right key map is given, in [45, 44, 20], to send a Kashiwara-Nakashima tableau T to its right key tableau $K_+(T)$, that detects the Demazure crystal atom which contains T . They are also computed in the type C_n alcove path model [36], and in the coloured five vertex model [11]. In [11], it is also computed the right key for reverse King tableaux [27]. Henceforth, the symplectic Demazure character $\kappa_v(x)$ is expressed in terms of right keys [45]

$$\kappa_v(x) = \sum_{\substack{T \in \mathfrak{B}(\lambda) \\ K_+(T) \leq K(v)}} x^{\text{wt}T},$$

where $K(v)$ is the key tableau of shape λ and weight v , $x^{\text{wt}T}$ is the weight monomial corresponding to T , with $\text{wt}T \in \mathbb{Z}^n$ the weight of T , and $K_+(T) \leq K(v)$ means entrywise comparison.

The *left key map* is dual to the right key map. It detects the tableaux which go in each *opposite* Demazure crystal [13]. Given $v \in W\lambda$, the opposite Demazure crystal \mathfrak{B}^{-v} is the image of Demazure crystal $\mathfrak{B}_v \subseteq \mathfrak{B}(\lambda)$ by the the Schützenberger-Lusztig involution on $\mathfrak{B}(\lambda)$ [45, Proposition 64]. The crystal $\mathfrak{B}(\lambda)$ can also be partitioned into opposite Demazure crystal atoms, \mathfrak{B}^u , where $u \in W\lambda$ runs in the Bruhat interval $-v \leq u \leq -\lambda$. Given a Demazure crystal and its opposite, for each tableau weight in the Demazure crystal there is a symmetric tableau weight in the opposite Demazure crystal.

Motivated by Lascoux' double crystal graph in type A [32], where Schützenberger *jeu de taquin* slides are used as crystal operators, we can attach a type A *cocrystal* to each vertex of the type C_n crystal of Kashiwara-Nakashima tableaux \mathfrak{B}^λ , in which the crystal operators are given by symplectic *jeu de taquin* slides on consecutive columns. Given a Kashiwara-Nakashima tableau T in $\mathfrak{B}(\lambda)$, the vertices of its cocrystal are Kashiwara-Nakashima skew tableaux connected to T via symplectic *jeu de taquin*. Our construction builds on Heo-Kwon work [18, Lemma 2.3, Lemma 2.4] and uses the dual RSK correspondence [17]. These cocrystals are type A crystals whose elements are type C_n Kashiwara-Nakashima skew tableaux, and contain all the needed information to compute the right and left key maps. Actually, the key skew tableaux of the cocrystal (Definition 4.9) provide all the needed information to compute left and right key maps of a Kashiwara-Nakashima tableau. The cocrystals also allow us to generalize the Proposition 7 [17, Appendix A.5] from semistandard Young tableaux to type C_n Kashiwara-Nakashima tableaux. This is an analogue of LS-paths which carry explicitly right and left keys as initial and final directions.

Jacon and Lecouvey have suggested, in [20], that Willis' method [51] to compute right and left keys in type A_{n-1} should be adaptable to type C_n . Motivated by Willis' direct inspection [51], we create an alternative algorithm, based on a Kashiwara-Nakashima tableau, for the symplectic right key map, and for the symplectic left key map, that does not use the symplectic *jeu de taquin*.

Due to the added technicality of the symplectic *jeu de taquin* compared to the one for SSYT, Willis' *earliest weakly increasing subsequence* will fail to predict what gets slid during the Lecouvey-Sheats symplectic *jeu de taquin*. Instead we need a way to calculate, without the use of *jeu de taquin*, what would appear in each column if we were to swap its length with the previous column length via *jeu*

de taquin. The role of Willis' sequences will be replaced by our matchings (see Section 6.1). In type A , these kind of matches were used earlier [1, 35] for jeu de taquin on two columns.

Lastly we prove that Baker virtualization [5] by folding A_{2n-1} into C_n commutes with dilatation of crystals [21]. Dilatation of crystals provide a constructive bijection between Kashiwara crystals and Littelmann crystals of L-S paths. Thus we may alternatively utilize the Baker virtualization to embed a type C_n Demazure crystal, its opposite and atoms into A_{2n-1} ones and compute symplectic right and left keys via type A methods.

The paper is organized in eight sections as follows. In Section 2, we discuss the type C Kashiwara-Nakashima tableaux and the symplectic *jeu de taquin*. Section 3 recalls the combinatorics of Kashiwara crystals, symplectic key tableaux, right and left key maps in terms of a Demazure crystal and opposite Demazure crystal and their parallel with the model of L-S paths and with Schubert varieties on a flag variety. In Section 4 we attach a type A *cocrystal* to each vertex of the type C_n crystal of Kashiwara-Nakashima tableaux $\mathfrak{B}(\lambda)$. Section 5 recalls the right and left key maps via symplectic *jeu de taquin* in [45], as a preparation for the alternative method without jeu de taquin. In Section 6, we give an algorithm for computing the symplectic right and left key maps that does not require the *jeu de taquin*, and prove that it returns the same object as the previous method. We end this Section, 6.5, with an illustrative example of our new algorithm and the one based on the Lecouvey-Sheats *jeu de taquin*. In Section 7 we show that Baker virtualization [5] commutes with dilatation of crystals [21] and virtualize the symplectic right and left keys maps. That is, symplectic keys can be computed via type A methods and returned back to the symplectic setting via reverse Baker embedding. We end this section by illustrating this method for symplectic Kashiwara crystals. As for the virtualization of the crystal of Lakshmibai-Seshadri paths for the Weyl group in type C , we explain the recipe as the size of the needed dilatation is in general big. Section 8 makes a remark on another possible method to compute symplectic keys.

An extended abstract [47] of a part of this paper, here §6.1, by the second author (JMS), was accepted in the Proceedings of the 33rd Conference on Formal Power Series and Algebraic Combinatorics, 2021. Also the content of §6 and partially of §4 appear in the PhD thesis [46] by the second author (JMS).

2. TYPE C KASHIWARA-NAKASHIMA TABLEAUX AND *jeu de taquin*

We recall the symplectic tableaux introduced by Kashiwara and Nakashima to label the vertices of the type C_n crystal graphs [26]. Fix $n \in \mathbb{N}_{>0}$. Define the sets $[n] = \{1, \dots, n\}$ and $[\pm n] = \{1, \dots, n, \bar{n}, \dots, \bar{1}\}$ where \bar{i} is just another way of writing $-i$, hence $\bar{\bar{i}} = i$. In the second set we will consider the following order of its elements: $1 < \dots < n < \bar{n} < \dots < \bar{1}$ instead of the usual order. A vector $\lambda = (\lambda_1, \dots, \lambda_n) \in \mathbb{Z}^n$ is a partition of $|\lambda| = \sum_{i=1}^n \lambda_i$ with at most n parts if $\lambda_1 \geq \lambda_2 \geq \dots \geq \lambda_n \geq 0$. Let \mathcal{P}_n be the set of partitions $\lambda = (\lambda_1, \dots, \lambda_n)$ with at most n parts. The *Young diagram* of shape λ , in English notation, is an array of boxes (or cells), left justified, in which the i -th row, from top to bottom, has λ_i boxes. We identify a partition with its Young diagram. For example, the Young

diagram of shape $\lambda = (2, 2, 1)$ is $\begin{array}{|c|c|} \hline \square & \square \\ \hline \square & \square \\ \hline \square & \\ \hline \end{array}$. Given μ and ν two partitions with $\nu \leq \mu$ entrywise, we write

$\nu \subseteq \mu$. The Young diagram of shape μ/ν is obtained after removing the boxes of the Young diagram of ν from the Young diagram of μ . For example, the Young diagram of shape $\mu/\nu = (2, 2, 1)/(1, 0, 0)$

is $\begin{array}{|c|c|} \hline \square & \square \\ \hline \square & \square \\ \hline \square & \\ \hline \end{array}$.

Let $\nu \subseteq \mu$ be two partitions and A a completely ordered alphabet. A *semistandard Young tableau* (SSYT) of skew shape μ/ν , on the alphabet A , is a filling of the diagram μ/ν with letters from A , such that the entries are strictly increasing, from top to bottom, in each column and weakly increasing, from left to right, in each row. When $|\nu| = 0$ then we obtain a semistandard Young tableau of straight shape μ . Denote by $\mathcal{SSYT}(\mu/\nu, A)$ the set of all skew SSYT's T of shape μ/ν , with entries in A . In particular, when $|\nu| = 0$ we write $\mathcal{SSYT}(\mu, A)$ and when $A = [n]$ we write $\mathcal{SSYT}(\mu/\nu, n)$.

When considering tableaux with entries in $[\pm n]$, it is usual to have some extra conditions besides being semistandard. We will use a family of tableaux known as *Kashiwara-Nakashima tableaux*. From now on we consider tableaux on the alphabet $[\pm n]$.

A *column* is a strictly increasing sequence of numbers (or letters) in $[\pm n]$ and it is usually displayed vertically. The height of a column is the number of letters in it. A column is said to be *admissible* if the following *one column condition* (1CC) holds for that column:

Definition 2.1 (1CC). Let C be a column. The 1CC holds for C if for all pairs i and \bar{i} in C , where i is in the a -th row counting from the top of the column, and \bar{i} in the b -th row counting from the bottom, we have $a + b \leq i$. Equivalently, for all pairs i and \bar{i} in C , the number $N(i)$ of letters x in C such that $x \leq i$ or $x \geq \bar{i}$ satisfies $N(i) \leq i$.

If a column C satisfies the 1CC then C has at most n letters. If 1CC doesn't hold for C we say that C *breaks the 1CC at z* , where z is the minimal positive integer such that z and \bar{z} exist in C and there are more than z numbers in C with absolute value less or equal than z .

Example 2.2. The column $\begin{array}{|c|} \hline 1 \\ \hline 2 \\ \hline \bar{1} \\ \hline \end{array}$ breaks the 1CC at 1, and $\begin{array}{|c|} \hline 2 \\ \hline 3 \\ \hline \bar{3} \\ \hline \end{array}$ is an admissible column.

The following definition states conditions to when C can be *split*:

Definition 2.3. Let C be a column and let $I = \{z_1 > \dots > z_r\}$ be the set of unbarred letters z such that the pair (z, \bar{z}) occurs in C . The column C can be split when there exists a set of r unbarred letters $J = \{t_1 > \dots > t_r\} \subseteq [n]$ such that:

1. t_1 is the greatest letter of $[n]$ satisfying $t_1 < z_1$, $t_1 \notin C$, and $\bar{t}_1 \notin C$,
2. for $i = 2, \dots, r$, we have that t_i is the greatest letter of $[n]$ satisfying $t_i < \min(t_{i-1}, z_i)$, $t_i \notin C$, and $\bar{t}_i \notin C$.

The 1CC holds for a column C (or C is admissible) if and only if C can be split [48, Lemma 3.1]. If C can be split then we define *right column* of C , rC , and the *left column* of C , ℓC , as follows:

1. rC is the column obtained by changing in C , \bar{z}_i into \bar{t}_i for each letter $z_i \in I$ and by reordering if necessary,
2. ℓC is the column obtained by changing in C , z_i into t_i for each letter $z_i \in I$ and by reordering if necessary.

If C is admissible then $\ell C \leq C \leq rC$ by entrywise comparison, where ℓC has the same barred part as C and rC the same unbarred part. If C doesn't have symmetric entries, then C is admissible and $\ell C = C = rC$. In the next definition we give conditions for a column C to be *coadmissible*.

Definition 2.4. We say that a column C is coadmissible if for every pair i and \bar{i} on C , where i is on the a -th row counting from the top of the column, and \bar{i} on the b -th row counting from the top, then $b - a \leq n - i$. Equivalently, for every pair i and \bar{i} on C , the number $N^*(i)$ of letters x in C such that $i \leq x \leq \bar{i}$ satisfies $N^*(i) \leq n - i + 1$.

Unlike in Definition 2.1, in the last definition b is counted from the top of the column.

Definition 2.5. Let C be a column and let $I = \{z_1 > \cdots > z_r\}$ be the set of unbarred letters z such that the pair (z, \bar{z}) occurs in C . The column C is coadmissible if and only if there exists a set of r unbarred letters $H = \{h_1 > \cdots > h_r\} \subseteq [n]$ such that:

1. h_r is the smallest letter of $[n]$ satisfying $h_r > z_r$, $h_r \notin C$, and $\bar{h}_r \notin C$,
2. for $i = r - 1, \dots, 1$, we have that h_i is the smallest letter of $[n]$ satisfying $h_i > \max(h_{i+1}, z_i)$, $h_i \notin C$, and $\bar{h}_i \notin C$.

Given an admissible column C , consider the map

$$\Phi : C \mapsto C^*$$

that sends C to the column C^* of the same size in which the unbarred entries are taken from ℓC and the barred entries are taken from rC .

Lemma 2.6. Let C be an admissible column on the alphabet $[\pm n]$, and I and J the sets in Definition 2.3. The entries x (barred or unbarred) of $\Phi(C)$ are such that

- (1) $x \in \Phi(C)$ and $\bar{x} \notin \Phi(C)$ if and only if $x \in C$ and $\bar{x} \notin C$.
- (2) $x, \bar{x} \in \Phi(C)$ if and only if $x \in J$ or $\bar{x} \in J$.

Equivalently, the set of entries in $\Phi(C)$ is $(J \cup \bar{J} \cup C) \setminus (I \cup \bar{I})$.

Henceforth, $\Phi(C) = C$ if and only if $I = \emptyset$ (hence $J = \emptyset$), that is, C does not have symmetric entries.

The column $\Phi(C)$ is a coadmissible column and the algorithm to form $\Phi(C)$ from C is reversible [34, Section 2.2]. In particular, every column on the alphabet $[n]$ is simultaneously admissible and coadmissible. The map Φ is a bijection between admissible and coadmissible columns of the same height on the alphabet $[\pm n]$.

Example 2.7. Let $C = \begin{array}{|c|} \hline 2 \\ \hline 4 \\ \hline \bar{2} \\ \hline \end{array}$ be an admissible column, so it can be split. Then $\ell C = \begin{array}{|c|} \hline 1 \\ \hline 4 \\ \hline \bar{2} \\ \hline \end{array}$ and $rC = \begin{array}{|c|} \hline 2 \\ \hline 4 \\ \hline \bar{1} \\ \hline \end{array}$.

So $\Phi(C) = \begin{array}{|c|} \hline 1 \\ \hline 4 \\ \hline \bar{1} \\ \hline \end{array}$ is coadmissible. C is also coadmissible and $\Phi^{-1}(C) = \begin{array}{|c|} \hline 3 \\ \hline 4 \\ \hline \bar{3} \\ \hline \end{array}$.

Let T be a skew tableau with all of its columns admissible. The *split form* of a skew tableau T , $spl(T)$, is the skew tableau obtained after replacing each column C of T by the two columns $\ell C rC$. The tableau $spl(T)$ has double the amount of columns of T .

A semistandard skew tableau T is a *Kashiwara-Nakashima (KN) skew tableau* if its split form is a semistandard skew tableau. We define $\mathcal{KN}(\mu/\nu, n)$ to be the set of all KN tableaux of shape μ/ν in the alphabet $[\pm n]$. When $\nu = 0$, we obtain $\mathcal{KN}(\mu, n)$. If T is a skew KN tableau, the *column reading* of T , $cr(T)$, is the word read in T in the Chinese/Japanese way, column reading top to bottom and right to left. The *length* of w is the total number of letters in w . The weight of a KN tableau T is the vector $\text{wt}(T) := \text{wt}(cr(T))$ in \mathbb{Z}^n whose i -th entry is the number of i 's minus the number of \bar{i} for $i \in [n]$ (see §3.2).

Example 2.8. Let $n = 3$. The split of the tableau $T = \begin{array}{|c|c|} \hline 2 & 2 \\ \hline 3 & 3 \\ \hline \bar{3} & \\ \hline \end{array}$ is the tableau $spl(T) = \begin{array}{|c|c|c|c|} \hline 1 & 2 & 2 & 2 \\ \hline 2 & 3 & 3 & 3 \\ \hline \bar{3} & \bar{1} & & \\ \hline \end{array}$.

Hence $T \in \mathcal{KN}((2, 2, 1), 3)$, $cr(T) = 2323\bar{3}$ and weight $\text{wt}(T) = (0, 2, 1)$.

If T is a tableau without symmetric entries in any of its columns, i.e., for all $i \in [n]$ and for all columns C in T , i and \bar{i} do not appear simultaneously in the entries of C , then in order to check

whether T is a KN tableau it is enough to check whether T is semistandard in the alphabet $[\pm n]$. In particular $\mathcal{SSYT}(\mu/\nu, n) \subseteq \mathcal{KN}(\mu/\nu, n)$.

2.1. Symplectic jeu de taquin. Lecouvey-Sheats symplectic *jeu de taquin* (SJDT) [34, 48] is a procedure on KN skew tableaux, compatible with *Knuth equivalence* (or plactic equivalence on words over the alphabet $[\pm n]$) [34], that allows us to change the shape of a tableau and to rectify it. To explain how the SJDT behaves, we need to look how it works on 2-column C_1C_2 KN skew tableaux. A skew tableau is *punctured* if one of its box contains the symbol $*$ called the *puncture*. A punctured column is admissible if the column is admissible when ignoring the puncture. A punctured skew tableau is admissible if its columns are admissible and the rows of its split form are weakly increasing ignoring the puncture. Let T be a punctured skew tableau with two columns C_1 and C_2 with the puncture in C_1 . In that case, the puncture splits into two punctures in $spl(T)$, and ignoring the punctures, $spl(T)$ must be semistandard. Let α be the entry under the puncture of rC_1 , and β the entry to the right of the puncture of rC_1 .

$$spl(T) = \ell C_1 r C_1 \ell C_2 r C_2 = \begin{array}{|c|c|c|c|} \hline \dots & \dots & \dots & \dots \\ \hline * & * & \beta & \dots \\ \hline \dots & \alpha & \dots & \dots \\ \hline \dots & \dots & & \\ \hline \end{array},$$

where α or β may not exist. The elementary steps of SJDT are the following:

A. If $\alpha \leq \beta$ or β does not exist, then the puncture of T will change its position with the cell beneath it. This is a vertical slide.

B. If the slide is not vertical, then it is horizontal. So we have $\alpha > \beta$ or α does not exist. Let C'_1 and C'_2 be the columns obtained after the slide. We have two subcases, depending on the sign of β :

1. If β is barred, we are moving a barred letter, β , from ℓC_2 to the punctured box of rC_1 , and the puncture will occupy β 's place in ℓC_2 . Note that ℓC_2 has the same barred part as C_2 and that rC_1 has the same barred part as $\Phi(C_1)$. Looking at T , we will have an horizontal slide of the puncture, getting $C'_2 = C_2 \setminus \{\beta\} \sqcup \{*\}$ and $C'_1 = \Phi^{-1}(\Phi(C_1) \setminus \{*\} \sqcup \{\beta\})$. In a sense, β went from C_2 to $\Phi(C_1)$.

2. If β is unbarred, we have a similar story, but this time β will go from $\Phi(C_2)$ to C_1 , hence $C'_1 = C_1 \setminus \{*\} \sqcup \{\beta\}$ and $C'_2 = \Phi^{-1}(\Phi(C_2) \setminus \{\beta\} \sqcup \{*\})$. Although in this case it may happen that C'_1 is no longer admissible. In this situation, if the ICC breaks at i , we erase both i and \bar{i} from the column and remove a cell from the bottom and from the top column, and place all the remaining cells orderly with respect to their entries.

Applying successively elementary SJDT slides, eventually, the puncture will be a cell such that α and β do not exist. In this case we redefine the shape to not include this cell and the *jeu de taquin* ends.

Given an admissible tableau T of shape μ/ν , a box of the diagram of shape ν such that boxes under it and to the right are not in that shape is called an inner corner of μ/ν . An outside corner is a box of μ such that boxes under it and to the right are not in the shape μ . The rectification of T consists in playing the SJDT until we get a tableau of shape λ , for some partition λ . More precisely, apply successively elementary SJDT steps to T until each cell of ν becomes an outside corner. At the end, we obtain a KN tableau for some shape λ . The rectification is independent of the order in which the inner corners of ν are filled [34, Corollary 6.3.9].

Example 2.9. Consider the KN skew tableau $T = \begin{array}{|c|c|} \hline & 2 \\ \hline 1 & 3 \\ \hline 2 & 1 \\ \hline \end{array}$. Let C_1 and C_2 be the first and second columns of T . To rectify T via symplectic *jeu taquin*, one creates a puncture in the inner corner of T

and, by splitting, one obtains $\begin{array}{|c|c|c|c|} \hline * & * & 2 & 2 \\ \hline 1 & 1 & 3 & 3 \\ \hline 2 & 2 & \bar{1} & \bar{1} \\ \hline \end{array}$. So, the first two slides are vertical, obtaining $\begin{array}{|c|c|c|c|} \hline 1 & 1 & 2 & 2 \\ \hline 2 & 2 & 3 & 3 \\ \hline * & * & \bar{1} & \bar{1} \\ \hline \end{array}$.

Finally, we do an horizontal slide, of type **B.1**, in which we take $\bar{1}$ from C_2 , and add it to the coadmissible column $\Phi(C_1)$. That is, $C'_2 = (C_2 \cup \{*\}) \setminus \bar{1}$ and $C'_1 = \Phi^{-1}((\Phi(C_1) \setminus \{*\}) \cup \bar{1})$, obtaining

the tableau $\begin{array}{|c|c|} \hline 2 & 2 \\ \hline 3 & 3 \\ \hline \bar{3} & \\ \hline \end{array}$.

Let T be a KN skew tableau of shape μ/ν (ν possibly empty). Consider a punctured box that can be added to μ , so that $\mu \cup \{*\}$ is a valid shape. The SJDT is reversible, meaning that we can move $*$, the empty cell outside of μ , to the inner shape ν of the skew tableau T , simultaneously increasing both the inner and outer shapes of T by one cell. The slides work similarly to the previous case: the vertical slide means that an empty cell is going up and an horizontal slide means that an entry goes from $\Phi(C_1)$ to C_2 or from C_1 to $\Phi(C_2)$, depending on whether the slid entry is barred or not, respectively. We will also call the *reverse jeu de taquin* as SJDT. In the next sections we will be mostly dealing with the *reverse jeu de taquin*. Consider the following examples, each containing a tableau

and a punctured box that will be slid to its inner shape: $\begin{array}{|c|c|c|} \hline & & * \\ \hline 1 & \bar{1} & \\ \hline 2 & & \\ \hline \end{array} \mapsto \begin{array}{|c|c|c|} \hline & & \\ \hline 1 & \bar{1} & \\ \hline 2 & & \\ \hline \end{array}; \quad \begin{array}{|c|c|} \hline & \\ \hline 1 & \bar{1} \\ \hline 2 & * \\ \hline \end{array} \mapsto \begin{array}{|c|c|} \hline & \\ \hline & 2 \\ \hline 2 & \bar{2} \\ \hline \end{array}.$

Remark 2.10. If a tableau with columns C_1 and C_2 does not have symmetric entries then the SJDT applied to $C_1 C_2$ coincides with the *jeu de taquin* known for SSYT's.

In sections 5 and ??, we use SJDT to swap lengths of consecutive columns in a skew tableau, to obtain skew tableaux Knuth related to a straight tableau, which is minimal for the number of cells within its Knuth class. Recall that in the elementary step *B.2* it is possible to lose cells. If we do a reverse elementary step *B.2* that results in having two more cells in the skew tableau, we would have to start by adding two symmetric entries to an admissible column, making it non admissible [34, Lemma 3.2.3], and then slide an unbarred cell to the column to its right. For instance, consider the following reverse elementary step *B.2* (\equiv denotes type C_n Knuth equivalence [34, Definition 3.2.1]):

$$\begin{array}{|c|c|} \hline 1 & * \\ \hline 2 & \\ \hline \end{array} \equiv \begin{array}{|c|c|} \hline 1 & * \\ \hline 2 & \\ \hline 3 & \\ \hline \bar{3} & \\ \hline \end{array} \equiv \begin{array}{|c|c|} \hline * & 1 \\ \hline 2 & \\ \hline 3 & \\ \hline \bar{3} & \\ \hline \end{array}.$$

The first and last skew tableaux are Knuth equivalent, but the middle tableau is not a KN skew tableau. The three semistandard tableaux are Knuth equivalent column words, via the contractor/dilator Knuth relation [34, Definition 3.2.1].

Hence, a reverse elementary step *B.2* that results in having more cells in the skew tableau has to be forced, since we have to start by forcing the existence of a non admissible column. This means that if we start with a minimal skew tableau, that is, a skew-tableau with the number of cells of its rectification, we can play SJDT, or its reverse, without ever incur in a loss/gain of boxes.

3. CRYSTALS, KEYS, DEMAZURE CRYSTALS AND THEIR OPPOSITE

In this section we review Demazure and opposite Demazure crystals and their atoms of a crystal in types A_{n-1} respectively C_n crystals $\mathfrak{B}(\lambda)$, where $\lambda \in \mathcal{P}_n$, and their detection with right and left key maps in [33, 45]. We also recall how right and left keys surface in appropriate dilatation of crystals [21, 24, 25], and apply it to the characterization of the intersection of Demazure and opposite Demazure crystals [22]. In addition Demazure and opposite Demazure crystals and their intersections are in

natural correspondence correspondence with Schubert, opposite Schubert varieties and Richardson varieties, as explained by the classical Borel-Weil theorem, which in turn amounts to the relevance of key maps in standard monomial theory as originally considered by Lascoux-Schützenberger in [33].

3.1. Kashiwara crystal. Let V be an Euclidean space with inner product $\langle \cdot, \cdot \rangle$. Fix a root system Φ with simple roots $\{\alpha_i \mid i \in I\}$ where I is an indexing set and a weight lattice $\Lambda \supseteq \mathbb{Z}\text{-span}\{\alpha_i \mid i \in I\}$. A *Kashiwara crystal* of type Φ is a nonempty set \mathfrak{B} together with maps [12]:

$$e_i, f_i : \mathfrak{B} \rightarrow \mathfrak{B} \sqcup \{0\} \quad \varepsilon_i, \varphi_i : \mathfrak{B} \rightarrow \mathbb{Z} \sqcup \{-\infty\} \quad \text{wt} : \mathfrak{B} \rightarrow \Lambda$$

where $i \in I$ and $0 \notin \mathfrak{B}$ is an auxiliary element, satisfying the following conditions:

(a) if $a, b \in \mathfrak{B}$ then $e_i(a) = b \Leftrightarrow f_i(b) = a$. In this case, we also have

$$(1) \quad \text{wt}(b) = \text{wt}(a) + \alpha_i, \text{ and } \varepsilon_i(b) = \varepsilon_i(a) - 1, \quad \varphi_i(b) = \varphi_i(a) + 1;$$

(b) for all $a \in \mathfrak{B}$, we have

$$(2) \quad \varphi_i(a) = \langle \text{wt}(a), \alpha_i^\vee \rangle + \varepsilon_i(a) \text{ with } \alpha_i^\vee = \frac{2\alpha_i}{\langle \alpha_i, \alpha_i \rangle}.$$

Let Λ^+ denote the set of dominant weights, that is, those $\lambda \in \Lambda$ such that $\langle \lambda, \alpha_i^\vee \rangle \geq 0$, for all $i \in I$. The root systems under consideration in this paper are of types A_{n-1} or C_n , thus $\Lambda = \mathbb{Z}^n$. For type A_{n-1} , $I = [n-1]$, and type C_n , $I = [n]$, and one has $\alpha_i^\vee = \alpha_i = \mathbf{e}_i - \mathbf{e}_{i+1}$, for $1 \leq i < n$, and, for $i = n$, in type C_n , $\alpha_n = 2\mathbf{e}_n$ and $\alpha_n^\vee = \mathbf{e}_n$ with $\mathbf{e}_i, i \in I$, the standard basis of \mathbb{R}^n . Thus $\Lambda^+ = \mathcal{P}_n$ in type C_n , and $\Lambda^+ = \{\lambda = (\lambda_1, \dots, \lambda_n) \in \mathbb{Z}^n : \lambda_1 \geq \dots \geq \lambda_n \geq 0\}$ in type A_{n-1} .

The crystals we deal with are seminormal [21, 24, 12], i.e., $\varphi_i(a) = \max\{k \in \mathbb{Z}_{\geq 0} \mid f_i^k(a) \neq 0\}$ and $\varepsilon_i(a) = \max\{k \in \mathbb{Z}_{\geq 0} \mid e_i^k(a) \neq 0\}$. An element $u \in \mathfrak{B}$ such that $e_i(u) = 0$ for all $i \in I$ is called a *highest weight element*. A *lowest weight element* is an element $u \in \mathfrak{B}$ such that $f_i(u) = 0$ for all $i \in I$.

We associate with \mathfrak{B} a coloured oriented graph with vertices in \mathfrak{B} and edges labeled by $i \in I$: $b \xrightarrow{i} b'$ if and only if $b' = f_i(b)$, $i \in I$, $b, b' \in \mathfrak{B}$. This is the *crystal graph* of \mathfrak{B} .

For types A_{n-1} and C_n , the Weyl groups are $W = \mathfrak{S}_n$ respectively $W = B_n$. The Weyl group W of type C_n , known as hyperoctahedral group, is the Coxeter group B_n ($2^n n!$ elements) generated by the involutions s_1, \dots, s_n (simple reflections) subject to relations $(s_i s_{i+1})^3 = 1, 1 \leq i < n-2$; $(s_{n-1} s_n)^4 = 1$; $(s_i s_j)^2 = 1, 1 \leq i < j \leq n, |i-j| > 1$. The subgroup generated by the simple reflections s_1, \dots, s_{n-1} is the symmetric group $\mathfrak{S}_n \subseteq B_n$. The elements of B_n can also be seen as the bijective maps σ on $[\pm n]$ such that $\sigma(-i) = -\sigma(i)$ and then B_n can be identified with the group of signed permutations with generators $s_i = (i \ i+1)(\bar{i}, \bar{i}+1), 1 \leq i < n, s_n = (n, \bar{n})$. The elements of the symmetric group can be identified with the permutation matrices, and if we allow the non-zero entries to be either 1 or -1 , we have the elements of B_n . The elements of W act on $z = (z_1, \dots, z_n) \in \mathbb{Z}^n$ by $s_i z := (z_1, \dots, z_{i+1}, z_i, \dots, z_n), 1 \leq i \leq n-1, s_n z = (z_1, \dots, \bar{z}_n)$. The long element of B_n , $w_0 = (s_1 s_2 \dots s_n)^n$, satisfies $w_0 z = -z$ in which case we may consider $w_0 = -Id$ to be the negative $n \times n$ identity matrix.

Let $G = Sp(2n, \mathbb{C}), GL(n, \mathbb{C})$ be the symplectic group and respectively the general linear group of degree n over \mathbb{C} . Let $\mathfrak{g} = \mathfrak{sp}(2n, \mathbb{C}), \mathfrak{gl}(n, \mathbb{C})$ be the corresponding Lie algebras. The finite dimensional irreducible representations of G are parameterized by partitions $\lambda \in \mathcal{P}_n$. For any $\lambda \in \mathcal{P}_n$, we denote by $V(\lambda)$ the corresponding finite dimensional irreducible representation (or \mathfrak{g} -module). To each partition $\lambda \in \mathcal{P}_n$ corresponds a (connected) crystal graph $\mathfrak{B}(\lambda)$ which can be seen as the combinatorial skeleton of the simple module $V(\lambda)$. In particular, its vertices label a distinguished basis of $V(\lambda)$. The crystal graph $\mathfrak{B}(\lambda)$ has various combinatorial realizations, that is, vertex labeling, as KN (resp. SSYT) tableaux, see Figure 1, or Littelmann's paths, in particular, Lakshmibai-Seshadri paths.

For any $i \in I$, the crystal $\mathfrak{B}(\lambda)$ can be decomposed into its i -chains (or i -strings) which are obtained just by keeping the i -arrows. There is a unique vertex b_λ in $\mathfrak{B}(\lambda)$ such that $e_i(b_\lambda) = 0$ for any $i \in I$,

that is, b_λ is the source vertex of each i -chain containing b_λ , called the **highest weight vertex** of $\mathfrak{B}(\lambda)$ in which case we have $\text{wt}(b_\lambda) = \lambda$. For any $b \in \mathfrak{B}(\lambda)$, there is a path $b = f_{i_1} \cdots f_{i_r}(b_\lambda)$ from b_λ to b , for some $i_1, \dots, i_r \in I$. The weight function wt satisfies

$$(3) \quad \text{wt}(b) = \lambda - \sum_{k=1}^r \alpha_{i_k}.$$

There is a unique vertex $b_{w_0\lambda}$ in $\mathfrak{B}(\lambda)$ such that $f_i(b_{w_0\lambda}) = 0$ for any $i \in I$, that is, $b_{w_0\lambda}$ is the sink vertex of each i -chain containing b_λ , called the **lowest weight vertex** of $\mathfrak{B}(\lambda)$ in which case we have $\text{wt}(b_{w_0\lambda}) = w_0\lambda$. This means that $\mathfrak{B}(\lambda)$ can be generated by applying all the sequences of lowering (resp. raising) Kashiwara operators f_i (resp. e_i) to b_λ (resp. $b_{w_0\lambda}$), as long they do not annihilate

For any $i \in I$, the crystal $\mathfrak{B}(\lambda)$ can be decomposed into its i -chains (or strings) which are obtained just by keeping the i -arrows. This means that, for each vertex b and each i in I there is only one i -string containing b .

$$(4) \quad \begin{array}{c} \overbrace{\quad\quad\quad}^{\varepsilon_i(b)} \quad \overbrace{\quad\quad\quad}^{\varphi_i(b') = \varepsilon_i(b)} \\ \bullet \quad \bullet \quad \bullet \quad \bullet \quad \bullet \quad \bullet \\ e_i^{\varepsilon_i(b)}(b) \quad e_i(b) \quad b \quad f_i(b) \quad \quad \quad f_i^{\varphi_i(b)}(b) \end{array}$$

For $b \in \mathfrak{B}(\lambda)$ and $i \in I$, we may then set $f_i^{\max}(b) := f_i^{\varphi_i(b)}(b)$, and $e_i^{\max}(b) := e_i^{\varepsilon_i(b)}(b)$.

Remark 3.1. When b is the source of an i -string, that is, $e_i(b) = 0 = \varepsilon_i(b)$, then from (2) $\varphi_i(b) = \langle \text{wt}(b), \alpha_i^\vee \rangle = \text{wt}_i(b) - \text{wt}_{i+1}(b) \geq 0$, $1 \leq i < n$, and, in type C_n , $\varphi_n(b) = \langle \text{wt}(b), \alpha_n^\vee \rangle = \text{wt}_n(b) \geq 0$, for $i = n$, is the length of the i -string, where $\text{wt}_i(b)$ indicates the i -th component of $\text{wt}(b) \in \mathbb{Z}^n$.

Henceforth, from (1)

$$\begin{aligned} \text{wt}(f_i^{\varphi_i(b)}(b)) &= \text{wt}(b) - \varphi_i(b)\alpha_i \\ &= \begin{cases} \text{wt}(b) - (\text{wt}_i(b) - \text{wt}_{i+1}(b))\alpha_i = s_i \text{wt}(b) & 1 \leq i < n, \\ \text{wt}(b) - \text{wt}_n(b)\alpha_n = s_n \text{wt}(b) & i = n. \end{cases} \end{aligned}$$

In particular $\varphi_i(b_\lambda) = \lambda_i - \lambda_{i+1}$, $1 \leq i < n$, and λ_n , for $i = n$, and $f_i^{\lambda_i - \lambda_{i+1}}(b_\lambda)$ with weight $s_i \lambda$ is uniquely determined by its weight. Similarly, when b is the sink of an i -string, in which case $\varepsilon_i(b) = -\langle \text{wt}(b), \alpha_i^\vee \rangle = -\text{wt}_i(b) + \text{wt}_{i+1}(b) \geq 0$, $1 \leq i < n$, and $\varepsilon_n(b) = -\langle \text{wt}(b), \alpha_n^\vee \rangle = -\text{wt}_n(b) \geq 0$, for $i = n$.

The Weyl group W acts on the vertices of $\mathfrak{B}(\lambda)$ [24]: the action of the simple reflection s_i on $\mathfrak{B}(\lambda)$ sends each vertex b on the unique vertex b' in the i -chain of b such that $\varphi_i(b') = \varepsilon_i(b)$ and $\varepsilon_i(b') = \varphi_i(b)$. Thus this means that b and b' correspond by the reflection with respect to the center of the i -chain containing b . More precisely, from (2) and (4),

$$s_i \cdot b = \begin{cases} f_i^{\varphi_i(b) - \varepsilon_i(b)}(b) = f_i^{\langle \text{wt}(b), \alpha_i^\vee \rangle}(b) & \text{if } \langle \text{wt}(b), \alpha_i^\vee \rangle \geq 0 \\ e_i^{\varphi_i(b) - \varepsilon_i(b)}(b) = e_i^{-\langle \text{wt}(b), \alpha_i^\vee \rangle}(b) & \text{if } \langle \text{wt}(b), \alpha_i^\vee \rangle \leq 0, \end{cases}$$

and $\text{wt}(s_i \cdot b) = s_i \cdot \text{wt}(b)$, for $i \in I$.

3.2. Tensor product of crystals and signature rule. If B and C are crystals, the crystal $B \otimes C$ has set of vertices the cartesian product of the sets of vertices of B and C , denoted $u \otimes v$, $u \in B$ and $v \in C$, and crystal structure given by $\text{wt}(u \otimes v) = \text{wt}(u) + \text{wt}(v)$ and the following rules where we

follow the Kashiwara convention [26, 21]

$$(5) \quad e_i(u \otimes v) = \begin{cases} u \otimes e_i(v) & \text{if } \varepsilon_i(v) > \varphi_i(u) \\ e_i(u) \otimes v & \text{if } \varepsilon_i(v) \leq \varphi_i(u) \end{cases} \quad \text{and} \quad f_i(u \otimes v) = \begin{cases} f_i(u) \otimes v & \text{if } \varphi_i(u) > \varepsilon_i(v) \\ u \otimes f_i(v) & \text{if } \varphi_i(u) \leq \varepsilon_i(v) \end{cases}.$$

We adopt the convention that $u \otimes 0 = 0 \otimes v = 0$. Given two partitions λ and μ in \mathcal{P}_n , the crystal graph of the representation $V(\lambda) \otimes V(\mu)$ is the crystal $\mathfrak{B}(\lambda) \otimes \mathfrak{B}(\mu)$ whose decomposition into connected components as well multiplicity correspond to the decomposition of $V(\lambda) \otimes V(\mu)$ into irreducible representations.

If B , C and D are crystals the map $(u \otimes v) \otimes z \mapsto u \otimes (v \otimes z)$ is a crystal isomorphism between $(B \otimes C) \otimes D$ and $B \otimes (C \otimes D)$. We also have $B \otimes C \simeq C \otimes B$ but the isomorphism is not natural. Let $b = b_1 \otimes \cdots \otimes b_r$. Then $\text{wt}(b) = \sum_{k=1}^r \text{wt}(b_k)$, and from (2),

$$(6) \quad \begin{aligned} \varphi(b) &= \max\{\varphi(b_k) + \sum_{k < u \leq r} \langle \text{wt}(b_u), \alpha^\vee \rangle : 1 \leq k \leq r\}, \\ \varepsilon(b) &= \max\{\varepsilon(b_k) - \sum_{1 \leq u < k} \langle \text{wt}(b_u), \alpha^\vee \rangle : 1 \leq k \leq r\}, \end{aligned}$$

and

$$(7) \quad \begin{aligned} f(b) &= b_1 \otimes \cdots \otimes (fb_{k_f}) \otimes \cdots \otimes b_r, \\ e(b) &= b_1 \otimes \cdots \otimes (eb_{k_e}) \otimes \cdots \otimes b_r, \end{aligned}$$

where k_f (k_e) is the biggest (smallest) integer such that

$$\varphi(b) = \varphi(b_k) + \sum_{k < u \leq r} \langle \text{wt}(b_u), \alpha^\vee \rangle \left(\varepsilon(b) = \varepsilon(b_k) - \sum_{1 \leq u < k} \langle \text{wt}(b_u), \alpha^\vee \rangle \right).$$

3.2.1. *The signature rule.* The tensor product of crystals allows us to define the crystal operators on arbitrary words on the alphabet $[\pm n]$ or KN skew tableaux so that one has a crystal structure in type C_n . Let $\Lambda_k = \mathbf{e}_1 + \cdots + \mathbf{e}_k$, $1 \leq k \leq n$, be the fundamental weights in type C_n . In type C_n , the standard crystal is seminormal and has the following crystal graph:

$$(8) \quad 1 \xrightarrow{1} 2 \xrightarrow{2} \cdots \xrightarrow{n-2} n-1 \xrightarrow{n-1} n \xrightarrow{n} \bar{n} \xrightarrow{n-1} \overline{n-1} \xrightarrow{n-2} \overline{n-2} \cdots \xrightarrow{2} \bar{2} \xrightarrow{1} \bar{1}$$

with set $\mathfrak{B} = [\pm n]$, $\text{wt}(\boxed{i}) = \mathbf{e}_i$, $\text{wt}(\overline{\boxed{i}}) = -\mathbf{e}_i$ [26, 12]. The highest weight element is the word 1, and the highest weight $\Lambda_1 = \mathbf{e}_1$. This is the crystal graph of the simple \mathfrak{sp}_{2n} -module, $V(\Lambda_1)$, and we denote it by $\mathfrak{B}(\Lambda_1)$. The crystal $\mathfrak{B}(\Lambda_1)$ is the crystal on the words of $[\pm n]^*$ with a sole letter. The tensor product of crystals allows us to define the crystal

$$(9) \quad G_n = \bigoplus_{k \geq 0} \mathfrak{B}(\Lambda_1)^{\otimes k}$$

of all words in $[\pm n]^*$, where the vertex $w_1 \otimes \cdots \otimes w_k$ is identified with the word $w_1 \dots w_k \in [\pm n]^*$ such that the weight $\text{wt}(w) = \sum_{i=1}^k \text{wt}(w_i)$. The irreducible representation $V(\Lambda_k)$, $1 \leq k \leq n$, is embedded into $V(\Lambda_1)^{\otimes k}$. Similarly the crystal $\mathfrak{B}(\Lambda_k)$ is embedded into $\mathfrak{B}(\Lambda_1)^{\otimes k}$ where the admissible column

$$\begin{array}{|c|} \hline u_1 \\ \hline \vdots \\ \hline u_k \\ \hline \end{array}$$

of length k is identified with the word $u_1 \otimes \cdots \otimes u_k$. Let $\lambda = \Lambda_{m_1} + \cdots + \Lambda_{m_k}$, $1 \leq m_1 \leq \cdots \leq m_k \leq n$. By the embedding of $V(\lambda)$ into $V(\Lambda_{m_1}) \otimes \cdots \otimes V(\Lambda_{m_k})$, $\mathfrak{B}(\lambda)$ is also embedded into $\mathfrak{B}(\Lambda_{m_1}) \otimes \cdots \otimes \mathfrak{B}(\Lambda_{m_k})$ and the KN tableau of shape λ and with columns $C_k \cdots C_1$ is identified with the word $C_1 \otimes \cdots \otimes C_k$.

The action of the operators e_i and f_i is easily given by the *signature rule* [26, 34, 21]. We substitute each letter w_j by $+$ if $w_j \in \{i, \overline{i+1}\}$ or by $-$ if $w_j \in \{i+1, \overline{i}\}$, and erase it in any other case. Then successively erase any pair $+-$ until all the remaining letters form a word that looks like $-^a +^b$. Then $\varphi_i(w) = b$ and $\varepsilon_i(w) = a$, e_i acts on the letter associated to the rightmost unbracketed $-$ (i.e., not erased), whereas f_i acts on the letter w_j associated to the leftmost unbracketed $+$,

$$(10) \quad f_i(w_j) = \begin{cases} i+1 & \text{if } w_j = i \text{ and } i \neq n \\ \overline{i} & \text{if } w_j = \overline{i+1} \\ \overline{n} & \text{if } w_j = i \text{ and } i = n, \end{cases}$$

and the other letters of w are unchanged, and e_i is the inverse map. If $b = 0$ then $f_i(w) = 0$ and if $a = 0$ then $e_i(w) = 0$.

The set $\mathcal{KN}(\lambda, n)$ (resp. $\mathcal{SSYT}(\lambda, n)$) is endowed with a Kashiwara crystal structure of type C_n (resp. A_{n-1}) [22, 34]. The crystal operators are fully characterized on words in the alphabet $[\pm n]$ (resp. $[n]$) or on KN skew tableaux (resp. skew SSYT) via the signature rule (10). We identify $\mathfrak{B}(\lambda)$ with $\mathcal{KN}(\lambda, n)$ (resp. $\mathcal{SSYT}(\lambda, n)$) in type C_n (respectively type A_{n-1}). Observe that $\mathcal{SSYT}(\lambda, n)$ is a subcrystal of $\mathfrak{B}(\lambda) = \mathcal{KN}(\lambda, n)$. See Figure 1.

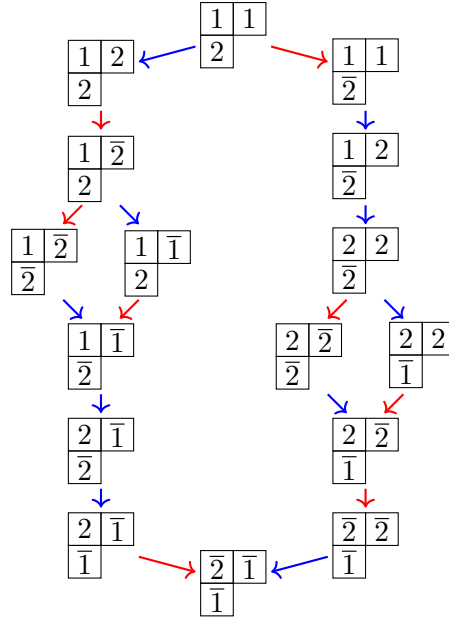

FIGURE 1. The type C_2 crystal graph $\mathcal{KN}((2,1),2)$ containing the A_1 crystal $\mathcal{SSYT}((2,1),2)$, consisting of the two top left most tableaux, as a subcrystal. The type C_2 lowering crystal operators are f_1 , \rightarrow , and f_2 , \rightarrow .

3.3. Bruhat order. For an element $w \in W$ as a Coxeter group, the minimum number of simple reflections needed to produce w is $\ell(w)$, the *length* of w . An expression of the form $s_{i_1} s_{i_2} \cdots s_{i_k}$ representing $\sigma \in W$ where all the s_{i_j} 's are simple reflections and $\ell(\sigma) = k$ is called a *reduced* decomposition of σ . The (*strong*) Bruhat order \leq on W as a Coxeter group can be defined by $\sigma' \leq \sigma$ in W if and only if there is a reduced decomposition of σ admitting a subexpression (not necessarily made of consecutive letters) which is a reduced decomposition of σ' , if and only if every reduced decomposition

of σ admits a subexpression which is a reduced decomposition of σ' (see [6, Corollary 2.2.3]). We refer the reader to [6] for basic statements on a finite Coxeter group.

Given any partition λ in \mathcal{P}_n , we denote by W_λ its *stabilizer* under the action of W , that is, W_λ is parabolic subgroup W_J , where $J = \{1 \leq i \leq n : \langle \lambda, \alpha_i^\vee \rangle = 0\}$. Each coset in W/W_λ contains a unique element of minimal length and the set of elements of minimal length is denoted by W^λ . Then each $\sigma \in W$ admits a unique decomposition of the form $\sigma = \sigma^\lambda \sigma'$ with $\sigma^\lambda \in W^\lambda$ and $\sigma' \in W_\lambda$, and $\ell(\sigma) = \ell(\sigma^\lambda) + \ell(\sigma')$. One then has a one-to-one correspondence between the elements of W^λ and $W\lambda$, the W -orbit of λ [7, 6]. (Similarly, for the unique element of maximal length in each coset in W/W_λ [6, Corollary 2.4.5].)

Remark 3.2. The induced (strong) Bruhat order of W on $W\lambda$ coincides with the restriction of the (strong) Bruhat order on W to W^λ .

- Consider the set $W\lambda$, which is in bijection with W^λ through $w\lambda \mapsto w^\lambda$, where w^λ is the representative of minimal length of wW_λ . Then the transitive closure of the relations

$$\mu < s_\alpha \mu, \text{ if } \langle \mu, \alpha^\vee \rangle > 0, s_\alpha \text{ a reflection in } W \text{ and } \mu \in W\lambda, \alpha \in \Phi^+$$

yields a partial order on $W\lambda$, which coincides through the aforementioned bijection with the restriction of the (strong) Bruhat order on W to W^λ . That is, $\mu < s_\alpha \mu$ if and only if $w^\lambda < (s_\alpha w)^\lambda$, where $\mu = w\lambda$ for some $w \in W$. It also amounts to note that, for $\mu < \nu$ in $W\lambda$ in the induced (strong) Bruhat order if and only if $\mu < s_{\alpha_1} \mu < \dots < s_{\alpha_r} \mu$ if and only if $w < (s_{\alpha_1} w)^\lambda < \dots < (s_{\alpha_r} w)^\lambda$ in W^λ , for some reflections t_1, \dots, t_r in W , and where $\mu = w\lambda$, and $\sigma\lambda$ for some $w, \sigma \in W$.

- The transpositions are the reflections in the symmetric group, and in B_n , seen as a subgroup of \mathfrak{S}_{2n} , the reflections are $(i - i)$, $(i j)(-i - j)$, $(i - j)(-i, j)$, $1 \leq i < j \leq n$.

Next we gather some properties of the long element w_0 of W useful in the sequel.

Remark 3.3. Let S be the set of generators of W , and $x, y, w \in W$. Then the long element w_0 in W has the following properties:

- $x \leq y$ if and only if $w_0 y \leq w_0 x$ (resp. $y w_0 \leq x w_0$) [7, Section 3.7], and
- $\ell(w_0 w) = \ell(w w_0) = \ell(w_0) - \ell(w)$, for all $w \in W$ [7, Section 3.7].
- We may write $w_0 w = w_0 s_{j_\ell} \dots s_{j_1} = s_{t_q} \dots s_{t_1}$ for some reduced words $w = s_{j_\ell} \dots s_{j_1}$ and $s_{t_q} \dots s_{t_1}$ in W where $q = \ell(w_0) - \ell(w)$ [6, Proposition 3.1.2].

Definition 3.4. A *key tableau* of shape λ , in type C_n , is a KN tableau in $\mathcal{KN}(\lambda, n)$ in which the set of elements of each column is contained in the set of elements of the previous column, left to right, if any, and the letters i and \bar{i} do not appear simultaneously as entries, for any $i \in [n]$. A *key tableau* of shape λ , in type A_{n-1} , or in $\mathcal{SSYT}(\lambda, n)$, is a key tableau of type C_n where all entries are positive.

Given a permutation $\sigma = [\sigma_1 \dots \sigma_n] \in B_n$ (respect. \mathfrak{S}_n) in window (respect. one-line) notation [45] and a partition λ with at most n parts, σ determines a key tableau K of shape λ and weight $\sigma\lambda$, denoted $K = K(\sigma\lambda)$, as follows: the entries in each column of K , say with j boxes, are just $\sigma_1, \dots, \sigma_j$ arranged in increasing order (top to bottom). (Note that in the window notation for B_n there are no symmetric entries.) In particular, either we consider the minimal or maximal representatives of a coset in W/W_λ the corresponding key tableaux are the same. The KN tableau K depends only upon the left coset σW_λ of the stabiliser subgroup W_λ of W , and the map $\sigma \mapsto K$ sets up a bijection between such cosets and key tableaux. (See [40] for type A_{n-1} .)

In fact, either in type A_{n-1} or C_n , it is possible to compute the unique minimal element of the coset σW_λ [45, Proposition 6] from the key $K(\sigma\lambda)$, a generalization of Lascoux' method for type A_{n-1} keys [32]. The unique maximal element in the coset σW_λ can also be computed using the same key and the same rule in [45, Proposition 6] but this time by reading along the key columns, bottom to top, right

to left, to maximize the number inversions [45, Proposition 1] among the elements in the coset. (See also [40], a recent method in type A_{n-1} to determine the left and right keys of a semistandard tableau where the unique maximal element representatives of the cosets are also considered.) For instance, consider $W = B_5$ and

$$K = \begin{array}{|c|c|c|c|c|} \hline 1 & 4 & 4 & \bar{5} & \bar{5} \\ \hline 4 & \bar{5} & \bar{5} & & \\ \hline \bar{5} & \bar{3} & \bar{3} & & \\ \hline \bar{3} & & & & \\ \hline \end{array}$$

with shape $\lambda = (5, 3, 3, 1, 0)$, weight $v = (1, 0, \bar{3}, 3, \bar{5}) \in W(5, 3, 3, 1, 0)$ and $\sigma = [\bar{5}4\bar{3}12] = \sigma^\lambda$, in window notation [45], is the minimal representative of the coset $\sigma W_\lambda = \sigma < s_2 >$, $W_\lambda = < s_2 > = \{1, s_2\}$. The maximal element in σW_λ is $[\bar{5}\bar{3}412]$.

Proposition 3.5. [45] *Let $W\lambda$ be equipped with the induced Bruhat order in W restricted to the set of minimal coset representatives in W^λ . Then, for $u, v \in W\lambda$, $u \leq v$ if and only if $K(u) \leq K(v)$ by entry-wise comparison (in the corresponding alphabets).*

For $\lambda = (\lambda_1 > \lambda_2 > \dots > \lambda_n)$ a stair partition, $W_\lambda = \{1\}$ and $W^\lambda = W$ and write just $K(\sigma)$ for $K(\sigma\lambda)$. If $\alpha, \beta \in W$ are written in window (one-line) notation then the Bruhat order in W has an alternative definition $\alpha \leq \beta \Leftrightarrow K(\alpha) \leq K(\beta)$ [45] and the latter inequality can be read as $K(\alpha) \leq K(\beta) \Leftrightarrow \alpha[i] \leq \beta[i]$, for $1 \leq i \leq n$, where we mean $\alpha[i] = \{a_1 < \dots < a_i\} \leq \beta[i] = \{b_1 < b_2 < \dots < b_i\}$ to be $a_k \leq b_k$, $1 \leq k \leq i$. (See also [17, 49] in type A_{n-1} .)

3.3.1. The keys poset. The highest weight element of $\mathfrak{B}(\lambda) = \mathcal{KN}(\lambda, n)$ (resp. $\mathcal{SSYT}(\lambda, n)$) is the key tableau $b_\lambda = K(\lambda)$ of shape and weight λ . Recall the Weyl group W acts on the vertices of $\mathfrak{B}(\lambda)$ (see §3.1) such that the simple reflection s_i sends each vertex b to the unique vertex $s_i b := b'$ in the i -chain of b where b' is given by the reflection with respect to the center of the i -chain containing b . In particular, any key tableau $K \neq K(\lambda)$ of shape λ is the vertex at the end of a i -chain of positive length belonging to a path of chains of positive lengths connected to $K(\lambda)$. More precisely, it can be obtained from $K(\lambda)$ by a sequence s_{i_r}, \dots, s_{i_1} of simple reflections, $K = K(s_{i_r} \dots s_{i_1} \lambda) = s_{i_r} K(s_{i_{r-1}} \dots s_{i_1} \lambda)$ corresponding to the sequence (i_1, \dots, i_r) -strings of positive length connecting $b_\lambda = K(\lambda)$ to $\sigma b_\lambda := b_{\sigma\lambda} = K$ with $\sigma = s_{i_r} \dots s_{i_1}$, where $b_{w_0\lambda} = K(w_0\lambda)$, with w_0 the longest element of W . We write

$$O(\lambda) = \{\sigma K(\lambda) = K(\sigma\lambda) \mid \sigma \in W^\lambda\}$$

for the orbit of the highest weight vertex $b_\lambda = K(\lambda)$ of $\mathfrak{B}(\lambda)$. Observe that $K(\sigma\lambda)$ is then the unique vertex in $\mathfrak{B}(\lambda)$ of weight $\sigma\lambda$. For each element of $W\lambda$ there is exactly one key tableau of shape λ with that weight. The elements of $O(\lambda)$, called the keys of $\mathfrak{B}(\lambda)$, are those vertices of $\mathfrak{B}(\lambda)$ which are completely characterized by their weight. As expected, one has a direct correspondence between the keys and the cosets of W/W_λ .

If in the crystal $\mathfrak{B}(\lambda)$ one just keeps the vertices in $O(\lambda)$ and the edges of the i -chains connecting them, this directed coloured graph defines a coloured poset for the left weak Bruhat order on the minimal representatives in W^λ . Recall the left weak Bruhat order in W can be defined by the cover relations $\sigma < s_i \sigma$ which holds whenever $\ell(s_i \sigma) = \ell(\sigma) + 1$, for $\sigma \in W$ and the simple reflection $s_i \in W$ [19]. Consider the weak Bruhat order in W induced on $W\lambda$ as in Remark 3.2 replacing the reflection s_α by a simple reflection s_i [19]. For $u = (u_1, \dots, u_n) \in W\lambda$, it means $u < s_i u$ whenever $\langle u, \alpha_i^\vee \rangle > 0$, $i \in I$, that is, $u_i > u_{i+1}$, $1 \leq i < n$, and $u_n > 0$ if $i = n$. For brevity, often we just refer weak Bruhat order since right weak Bruhat order will not be used. Therefore, one has the following assertions.

Proposition 3.6. *For $u \in W\lambda$, $i \in I$ and $s_i \in W$. The following assertions are equivalent*

- (1) $K(u) < K(s_i u)$.
- (2) $u < s_i u$ which happens when $\langle u, \alpha_i^\vee \rangle > 0$.

- (3) *There is a crystal i -chain from $K(u)$ to $K(s_i u)$ of length $\langle u, \alpha_i^\vee \rangle > 0$.*
(4) $f_i^{\max}(K(u)) = K(s_i u)$, with $\max = \varphi_i(K(u)) = \langle u, \alpha_i^\vee \rangle > 0$.

By Proposition 3.5, one has $\lambda < u$ in $W\lambda$ if and only if $K(\lambda) < K(u)$. By the crystal string property this happens when there is a weak saturated chain in $W\lambda$ from λ to u , that is,

$$\begin{aligned} K(\lambda) < K(u) &\Leftrightarrow K(\lambda) < K(s_{i_1} \lambda) < K(s_{i_2} s_{i_1} \lambda) < \cdots < K(s_{i_r} \cdots s_{i_1} \lambda) = K(u) \\ &\Leftrightarrow \lambda < s_{i_1} \lambda < s_{i_2} s_{i_1} \lambda < \cdots < s_{i_r} \cdots s_{i_1} \lambda = u \\ (11) \quad &\Leftrightarrow \lambda < u. \end{aligned}$$

for some (i_r, \dots, i_1) coloured sequence of strings (of positive lengths) in $\mathfrak{B}(\lambda)$ connecting $K(\lambda)$ to $K(u)$. Indeed, (11) means that $\lambda < w\lambda$, $w \in W$, if and only if there is a chain of reduced words $1 < s_{i_1}^\lambda = s_{i_1} < (s_{i_2} s_{i_1})^\lambda \cdots < (s_{i_r} \cdots s_{i_1})^\lambda = w^\lambda$ in W^λ . This also means that there is a (i_r, \dots, i_1) coloured sequence of strings (of positive lengths) such that

$$(12) \quad f_{i_r}^{\langle s_{i_{r-1}} \cdots s_{i_1} \lambda, \alpha_{i_r}^\vee \rangle} \cdots f_{i_2}^{\langle s_{i_1} \lambda, \alpha_{i_2}^\vee \rangle} f_{i_1}^{\langle \lambda, \alpha_{i_1}^\vee \rangle} (K(\lambda)) = K(u),$$

or equivalently

$$f_{i_r}^{\max} \cdots f_{i_2}^{\max} f_{i_1}^{\max} (K(\lambda)) = K(u) \quad \text{with all max positive.}$$

Thus we may write

$$(13) \quad O(\lambda) = \{f_{j_r}^{\max} \cdots f_{j_1}^{\max} (K(\lambda)) \mid j_1, \dots, j_r \in I, r \geq 0\},$$

noting that $f_j^{\max}(K(u)) := f_j^{\varphi_j(K(u))} (K(u)) = K(s_j u)$ if $\max = \varphi_j(K(u)) = \langle \mu, \alpha_j^\vee \rangle > 0$ and $K(u)$ if $\langle u, \alpha_j^\vee \rangle = 0$.

Example 3.7. Let $n = 5$, $\lambda = (2, 2, 2, 1, 0)$, and

$$K(\lambda) = \begin{array}{|c|c|} \hline 1 & 1 \\ \hline 2 & 2 \\ \hline 3 & 3 \\ \hline 4 & \\ \hline \end{array} \xrightarrow{f_3 = f_3^{\max}} K(s_3 \lambda) = \begin{array}{|c|c|} \hline 1 & 1 \\ \hline 2 & 2 \\ \hline 3 & 4 \\ \hline 4 & \\ \hline \end{array} \xrightarrow{f_4^2 = f_4^{\max}} K(s_4 s_3 \lambda) = \begin{array}{|c|c|} \hline 1 & 1 \\ \hline 2 & 2 \\ \hline 3 & 5 \\ \hline 5 & \\ \hline \end{array}.$$

One then has

$$\begin{aligned} &K(\lambda) < K(s_3 \lambda) < K(s_4 s_3 \lambda) \text{ by entrywise comparison} \Leftrightarrow \\ &\Leftrightarrow \lambda = (2, 2, 2, 1, 0) < s_3 \lambda = (2, 2, 1, 2, 0) < s_4 s_3 \lambda = (2, 2, 1, 0, 2) \text{ in } W\lambda, \end{aligned}$$

and from Proposition 3.5

$$1 < s_3 = s_3^\lambda = [12435] < (s_4 s_3)^\lambda = [12534] \neq s_4 s_3 = [12453] \text{ in } W^\lambda.$$

3.4. Keys, dilatation of crystals and Lakshmibai-Seshadri paths. Let m be a positive integer and λ a partition in \mathcal{P}_n . There exists a unique embedding of crystals $\psi_m : \mathfrak{B}(\lambda) \hookrightarrow \mathfrak{B}(m\lambda)$ such that for any vertex $b \in \mathfrak{B}(\lambda)$ and any path $b = f_{i_1} \cdots f_{i_r}(b_\lambda)$ in $\mathfrak{B}(\lambda)$, we have [25, 21]

$$\psi_m(b) = f_{i_1}^m \cdots f_{i_r}^m (b_{m\lambda}).$$

Since the vertex $b_\lambda^{\otimes m}$ is of highest weight $m\lambda$ in $\mathfrak{B}(\lambda)^{\otimes m}$, one gets a particular realization $\mathfrak{B}(b_\lambda^{\otimes m})$ of $\mathfrak{B}(m\lambda)$ in $\mathfrak{B}(\lambda)^{\otimes m}$ with highest weight vertex $b_\lambda^{\otimes m}$. This gives a canonical embedding

$$(14) \quad \theta_m : \begin{cases} \mathfrak{B}(b_\lambda) \hookrightarrow \mathfrak{B}(b_\lambda^{\otimes m}) \subset \mathfrak{B}(b_\lambda)^{\otimes m} \\ b \longmapsto b_1 \otimes \cdots \otimes b_m \end{cases}$$

with important properties given in the theorem below.

Theorem 3.8. (see [25, 21, 2])

- (1) Let $\sigma \in W^\lambda$. We have $\theta_m(b_{\sigma\lambda}) = b_{\sigma\lambda}^{\otimes m}$.

- (2) Let $b \in \mathfrak{B}(\lambda)$. When m has sufficiently many factors, in general, the least common multiple of the maximal i -string lengths, there exist elements $\sigma_1, \dots, \sigma_m$ in W^λ such that $\theta_m(b) = b_{\sigma_1\lambda} \otimes \dots \otimes b_{\sigma_m\lambda}$. Moreover, in this case
- the elements $b_{\sigma_1\lambda}$ and $b_{\sigma_m\lambda}$ in $\theta_m(b)$ do not then depend on m ,
 - up to repetition, the sequence $(\sigma_1\lambda, \dots, \sigma_m\lambda)$ in $\theta_m(b)$ does not depend on the realization of the crystal $\mathfrak{B}(\lambda)$ and we have $\sigma_1 \geq \sigma_2 \geq \dots \geq \sigma_m$.

We define the pair of keys, right and left, of an element in $\mathfrak{B}(\lambda)$ as follows.

Definition 3.9. Let $b \in \mathfrak{B}(\lambda)$. The keys $K^+(b)$, the right key, and $K^-(b)$, the left key, of b are defined as follows:

$$K^+(b) = b_{\sigma_1\lambda} \text{ and } K^-(b) = b_{\sigma_m\lambda}.$$

In particular, $K^+(b_{\sigma\lambda}) = K^-(b_{\sigma\lambda}) = b_{\sigma\lambda}$ for any $\sigma \in W^\lambda$. The orbit $O(\lambda)$ is simultaneously the set of all left and right keys of $\mathfrak{B}(\lambda)$.

See Figure 2 for an example in type C, and [2, Example 2.12] for an example in type A.

Remark 3.10. [21, Chapitre 8], [2, Section 2.3.2] $K^-(b) \leq K^+(b)$ for any $b \in \mathfrak{B}(\lambda)$, and $K^-(b) = K^+(b)$ if and only if b is in $O(\lambda)$.

Remark 3.11. (1) A Lakshmibai-Seshadri path can be described as a W -path satisfying certain integrality conditions. We refer the reader to [37, 29] for further details. (See also [13].) Let $\lambda \in \Lambda^+$ and consider the Bruhat order on W/W_λ . Let $\tau = (\tau_0 > \dots > \tau_r)$ be a strictly decreasing sequence of elements of W/W_λ and let $\mathbf{a} = (0 < a_1 < \dots < a_r < 1)$ be strictly increasing sequence of rational numbers. The pair $\pi = (\tau, \mathbf{a})$ is called a rational W -path of shape λ or a convex subset of shape λ of the orbit $W\lambda$ [29]. If in addition the pair $\pi = (\tau, \mathbf{a})$ satisfies certain integrality conditions [37, 29] then is called a Lakshmibai-Seshadri (L-S) path of shape λ .

Let $\mathbf{B}(\lambda)$ be the crystal of Lakshmibai-Seshadri (L-S) paths of shape λ [37]. The crystal of L-S paths of shape λ is isomorphic to the Kashiwara crystal $\mathfrak{B}(\lambda)$ [25]. The dilatation of crystals was the main tool for proving that Littelmann's crystals obtained from its path model coincide with Kashiwara's ones. It is enough to show it for L-S path model that it is what we got from the dilatation [21, Chapitre 8]. If $\pi = (\tau, \mathbf{a})$ is an L-S path of shape λ , the sequence $\tau = (\tau_0, \dots, \tau_r)$ strictly decreasing in the Bruhat order on W/W_λ . We call $i(\pi) = \tau_0$, the initial direction and $e(\pi) = \tau_r$, the final direction of the path which coincide with the right key respectively left key of the corresponding vertex b in $\mathfrak{B}(\lambda)$. That is, $K^+(b) = K(\tau_0\lambda) = b_{\tau_0\lambda}$ and $K^-(b) = K(\tau_r\lambda) = b_{\tau_r\lambda}$.

- (2) Indeed Theorem 3.8, Assertion (2), gives a procedure to compute the right and left key maps on a abstract crystal. However this method is not in general effective when m is big. (In general we take the least common multiple of the maximal string lengths.). Despite the terminology "left" and "right" keys as in the original Lascoux's definition [33], based on the tableau model realization, does not fit with the positions of $b_{\sigma_1\lambda}$ and $b_{\sigma_k\lambda}$ in $\theta_k(b)$ we still keep it.

In the type A tableau crystal model there are currently many ways to compute the right and left key maps besides the original ones based on frank words and JDT [33]. By direct inspection of a Young tableau, Willis [51] has given an alternative algorithm to compute the right key tableau that does not require the use of *jeu de taquin*. Other methods to compute the type A right key map includes *semi skyline augmented fillings* by Mason [41], and the alcove path model by Lenart [36], for instance. For new methods and a complete overview in type A, see [10] and the references therein. See also for a recent new method given in [40] based on Deodhar lifts known in standard monomial theory developed by Lakshmibai, Musili, and Seshadri [30] and references therein.

In [45] the second author Santos has defined type C frank words on the alphabet $[\pm n]$ and used them to create the right and left key maps, that send KN tableaux to key tableaux in type C to be recalled in Section 5. See also [20]. In addition, in [47], motivated by the Willis' direct way for semistandard tableaux, a direct way for computing the right key of a KN tableau was also provided. This direct procedure is here also shown for left keys [46]. Alternatively, in §7, using the Baker imbedding, we virtualize the symplectic right and left keys in A_{2n-1} . Simultaneously, Baker embedding also virtualizes the L-S path crystal $\mathbf{B}(\lambda)$.

3.5. Schützenberger-Lusztig involution and dual crystal. Crystals corresponding to finite-dimensional (quantum group) $U_q(\mathfrak{g})$ -representations belong to a family of crystals called *normal crystals* [12]. In classical types, these crystals may be realized by a tableau model [26] and have nice combinatorial properties. Normal crystals arise as the crystals associated to the finite-dimensional representations of a quantum group $U_q(\mathfrak{g})$ for some Lie algebra \mathfrak{g} [12]. Let I be the Dynkin diagram associated to the root system of \mathfrak{g} . Let us recall the definition of Lusztig involution, also called Schützenberger involution in type A_{n-1} . Consider the Dynkin diagram automorphism, a permutation of its nodes which leaves the diagram invariant, $\theta : I \rightarrow I$ defined by $\alpha_{\theta(i)} = -w_0\alpha_i$, α_i is the i -th simple root at node $i \in I$, where w_0 is the longest element of the Weyl group W . For type A_{n-1} we have that w_0 is the reverse permutation and $\theta(i) = n - i$, and for type C_n we have $w_0 = -\text{Id}$ and $\theta(i) = i$, where Id is the identity map.

Definition 3.12. Let \mathfrak{B} be a normal crystal. The Lusztig involution $\xi : \mathfrak{B} \rightarrow \mathfrak{B}$ is the only set involution such that for all $i \in I$ ($I = [n - 1]$ in type A_{n-1} and $I = [n]$ in type C_n):

- (1) $\text{wt}(\xi(x)) = w_0(\text{wt}(x))$, where w_0 is the longest element of the Weyl group;
- (2) $e_i(\xi(x)) = \xi(f_{\theta(i)}(x))$ and $f_i(\xi(x)) = \xi(e_{\theta(i)}(x))$;
- (3) $\varepsilon_i(\xi(x)) = \varphi_{\theta(i)}(x)$ and $\varphi_i(\xi(x)) = \varepsilon_{\theta(i)}(x)$.

The involution map ι is an involution on $\mathfrak{B}(\lambda)$ reversing the arrows while flipping the labels i , and $\theta(i)$, $i \in I$, and applying w_0 to the weight of each vertex. (In type C_n the labels are preserved and the weights change of sign, and in type A_{n-1} , the edge labels are flipped by $i \mapsto n - i$, and and vertex weights are reversed.) If $b \in \mathfrak{B}(\lambda)$ then $b = f_{i_\ell}^{k_\ell} \cdots f_{i_1}^{k_1}(b_\lambda)$ for some $i_1, \dots, i_\ell \in I$ and $k_{i_1}, \dots, k_{i_\ell} \geq 0$, and $\xi(b) = e_{\theta(i_\ell)}^{k_\ell} \cdots e_{\theta(i_1)}^{k_1}(b_{w_0\lambda})$.

Let \mathfrak{C} be a connected component in the crystal G_n (9). The dual crystal \mathfrak{C}^\vee is the crystal obtained from \mathfrak{C} after reversing the direction of all arrows, and if $x \in \mathfrak{C}$, then for the corresponding x^\vee in \mathfrak{C}^\vee , we have $-\text{wt}(x) = \text{wt}(x^\vee)$ [12]. For example, in type A_{n-1} ,

$$(15) \quad \mathfrak{B}(\Lambda_1) : 1 \xrightarrow{1} 2 \xrightarrow{2} \cdots \xrightarrow{n-2} n-1 \xrightarrow{n-1} n, \\ \mathfrak{B}^\vee(\Lambda_1) = \mathfrak{B}(-w_0\Lambda_1) : -1 \xleftarrow{1} -2 \xleftarrow{2} \cdots \xleftarrow{n-2} -n+1 \xleftarrow{n-1} -n.$$

and in type C_n , since $w_0 = -\text{Id}$, $\mathfrak{B}^\vee(\Lambda_1) = \mathfrak{B}(\Lambda_1)$, and from (8), we get

$$\bar{1} \xleftarrow{1} \bar{2} \xleftarrow{2} \cdots \xleftarrow{n-2} \overline{n-1} \xleftarrow{n-1} \bar{n} \xleftarrow{n} n \xleftarrow{n-1} n-1 \xleftarrow{n-2} n-2 \xleftarrow{n-3} \cdots \xleftarrow{2} 2 \xleftarrow{1} 1.$$

In type C_n , it then follows from the definition that \mathfrak{C} and \mathfrak{C}^\vee , as crystals in G_n , have the same highest weight, and, therefore, they are isomorphic. Since $\theta_i(i) = i$, the Lusztig involution is a realization of the dual crystal and the crystal $\mathfrak{B}(\lambda)$ is self-dual, that is $\mathfrak{B}^\vee(\lambda) = \mathfrak{B}(\lambda)$. In type A_{n-1} , we may identify $\mathfrak{B}^\vee(\lambda) = \mathfrak{B}(-w_0\lambda)$ a \mathfrak{gl}_n -crystal with highest weight $-w_0\lambda$ realized by the Stembridge rational tableaux [50]. See [28] for details.

Remark 3.13. Let $G = Sp(2n, \mathbb{C})$ be the symplectic group or $G = GL(n, \mathbb{C})$ the general linear group. Let $V(\lambda)$ be the irreducible G -module with highest weight λ and let $\mathfrak{B}(\lambda)$ be the associated kashiwara

crystal. Let $V^*(\lambda)$ be the corresponding dual G -module of $V(\lambda)$. Then $V^*(\lambda) \simeq V(-w_0\lambda)$ with dual crystal $\mathfrak{B}^\vee(\lambda) = \mathfrak{B}(-w_0\lambda)$. When $G = Sp(2n, \mathbb{C})$, then $V^*(\lambda) \simeq V(\lambda)$ with crystal $\mathfrak{B}^\vee(\lambda) = \mathfrak{B}(\lambda)$.

If $\mathfrak{B}(\lambda)$ is the type C_n (respect. A_{n-1}) crystal then the Schützenberger-Lusztig involution $\xi(T)$, for $T \in \mathfrak{B}(\lambda)$ with tableau realization can be computed via the Schützenberger evacuation, evac which consists in π -rotating T , swapping all of its entries i by $w_0(i)$ for all i , and finally rectifying it via symplectic jeu de taquin, obtaining $\xi(T) = \text{evac}(T)$ [45, Section 5.1, Algorithm 59].

Remark 3.14. The right key of a tableau is the evacuation of the left key of the evacuation of the same tableau $K^+(b) = \text{evac}K^-(\text{evac } b)$ [45, Proposition 64].

3.6. Demazure crystal, its opposite, their intersection and Schubert varieties. We scrutinize the structure of Demazure crystals, opposite Demazure crystals and their intersections and analyse the parallels with Schubert varieties via the Borel-Weil theorem.

3.6.1. Demazure crystal. Given a subset X of $\mathfrak{B}(\lambda)$, consider the operator \mathfrak{D}_i on X , with $i \in [n]$ defined by $\mathfrak{D}_i X = \{x \in \mathfrak{B}(\lambda) \mid e_i^k(x) \in X \text{ for some } k \geq 0\}$ [12]. That is, $\mathfrak{D}_i X = \{f_i^k(x) : x \in X, k \geq 0\} \setminus \{0\}$ consist of the union of all sections of i -strings from $x \in X$ to $f_i^{\max}(x)$. If $v = \sigma\lambda$ where $\sigma = s_{i_\ell} \cdots s_{i_1} \in W$ is a reduced word, we define the *Demazure crystal* \mathfrak{B}_v (also denoted $\mathfrak{B}_\sigma(\lambda)$) to be

$$(16) \quad \begin{aligned} \mathfrak{B}_v &= \mathfrak{D}_{i_\ell} \cdots \mathfrak{D}_{i_1} \{K(\lambda)\} \\ &= \{f_{i_\ell}^{k_\ell} \cdots f_{i_1}^{k_1}(K(\lambda)) \mid (k_\ell, \dots, k_1) \in \mathbb{Z}_{\geq 0}^\ell\} \setminus \{0\}. \end{aligned}$$

Indeed if $\sigma = e$, $\mathfrak{B}_e(\lambda) = \mathfrak{B}_\lambda = \{K(\lambda)\}$, and if $\sigma = w_0$, $\mathfrak{B}_{w_0}(\lambda) = \mathfrak{B}(\lambda)$. This definition is independent of the reduced word for σ [12, Theorem 13.5]. It is also independent of the coset representative of σW_λ , that is, $\mathfrak{B}_{\sigma\lambda} = \mathfrak{B}_{\sigma_v\lambda}$ and $\mathfrak{B}_{\sigma'\lambda} = \mathfrak{B}_\lambda = \{K(\lambda)\}$ for $\sigma^\lambda \in W^\lambda$ the minimal representative of that coset, respectively $\sigma' \in W_\lambda$ [45].

If $\rho \leq \sigma$, for the Bruhat order of W , then $u = \rho\lambda \leq v$ in $W\lambda$, equivalently $\rho^\lambda \leq \sigma^\lambda$ in W^λ [6, Proposition 2.5.1]. Since $f_i^0(x) = x$, if $\rho \leq \sigma$ then $\mathfrak{B}_u \subseteq \mathfrak{B}_v$. Thus we define the *Demazure crystal atom* $\overline{\mathfrak{B}}_v$ to be

$$\overline{\mathfrak{B}}_v = \mathfrak{B}_v \setminus \bigsqcup_{u \in W\lambda, u < v} \mathfrak{B}_u = \mathfrak{B}_v \setminus \bigsqcup_{K(u) < K(v)} \mathfrak{B}_u.$$

Every Demazure crystal atom contains exactly one key tableau. The right key map K^+ , Theorem 3.8, Assertion (2), or [33] and [45, Theorem 14, Theorem 17] in types A and C respectively, sends each tableau of $\mathfrak{B}(\lambda)$ to the unique key tableau living in the Demazure crystal atom that contains the given tableau. See Figures 2 and 4. Thereby,

$$(17) \quad \overline{\mathfrak{B}}_v = \{b \in \mathfrak{B}(\lambda) : K^+(b) = K(v)\},$$

$$(18) \quad \mathfrak{B}_v = \bigsqcup_{v' \in W\lambda, v' \leq v} \overline{\mathfrak{B}}_{v'} = \{b \in \mathfrak{B}(\lambda) : K^+(b) \leq K(v)\}.$$

Remark 3.15. For Cartan type C_n , since $K(-v) = \text{evac } K(v)$, and $K^-(b) = \text{evac}K^+(\text{evac } b)$, it follows from (18),

$$\begin{aligned} \mathfrak{B}_{-v} &= \bigsqcup_{v' \in W\lambda, v' \geq v} \overline{\mathfrak{B}}_{-v'} = \{b \in \mathfrak{B}(\lambda) : \text{evac}K^+(b) \geq K(v)\} \\ &= \{b \in \mathfrak{B}(\lambda) : K^-(\text{evac } b) \geq K(v)\}. \end{aligned}$$

Example 3.16. For Cartan type C_2 , $\lambda = (2, 1)$, $v = (1, -2)$, one has

- (1) $\mathfrak{B}_v = \mathfrak{B}_{s_2s_1(2,1)} = \overline{\mathfrak{B}}_{(2,1)} \sqcup \overline{\mathfrak{B}}_{(1,2)} \sqcup \overline{\mathfrak{B}}_{(2,-1)} \sqcup \overline{\mathfrak{B}}_{(1,-2)}$, since $1, s_1, s_2 < s_2s_1 \Rightarrow \lambda, s_1\lambda, s_2\lambda < s_2s_1\lambda$, and

(2) $\mathfrak{B}_{-v} = \mathfrak{B}_{(-1,2)} = \mathfrak{B}_{w_0(1,-2)} = \mathfrak{B}_{s_1 s_2(2,1)}$ where $w_0 s_2 s_1 = s_1 s_2$ in $W = B_2$. Then

$$\begin{aligned} \mathfrak{B}_{-v} &= \{f_1^{k_1} f_2^{k_2}(K(2,1)) \mid (k_2, k_1) \in \mathbb{Z}_{\geq 0}^2\} \setminus \{0\} \\ &= \overline{\mathfrak{B}}_{(2,1)} \sqcup \overline{\mathfrak{B}}_{(2,-1)} \sqcup \overline{\mathfrak{B}}_{(1,2)} \sqcup \overline{\mathfrak{B}}_{(-1,2)} \\ &= \overline{\mathfrak{B}}_{(-2,-1)} \sqcup \overline{\mathfrak{B}}_{(-2,1)} \sqcup \overline{\mathfrak{B}}_{(-1,-2)} \sqcup \overline{\mathfrak{B}}_{(-1,-2)}. \end{aligned}$$

3.6.2. *Opposite Demazure crystal.* Analogously to the previous case, we start by creating an opposite operator \mathfrak{D}_i^{op} on X , with $i \in [n]$ defined by $\mathfrak{D}_i^{op} X = \{x \in \mathfrak{B}(\lambda) \mid f_{\theta(i)}^k(x) \in X \text{ for some } k \geq 0\}$. That is, $\mathfrak{D}_i^{op} X = \{e_{\theta(i)}^k(x) \mid x \in X, k \geq 0\} \setminus \{0\}$. If $v = \sigma\lambda$ and $\sigma = s_{i_\ell} \cdots s_{i_1} \in W$ is a reduced word, we define the *opposite Demazure crystal* $\mathfrak{B}^{w_0 v} = \mathfrak{B}^{w_0 \sigma}(\lambda)$ to be

$$\begin{aligned} \mathfrak{B}^{w_0 v} &:= \mathfrak{D}_{i_\ell}^{op} \cdots \mathfrak{D}_{i_1}^{op} \{K(w_0 \lambda)\} \\ &= \{e_{\theta(i_\ell)}^{k_\ell} \cdots e_{\theta(i_1)}^{k_1}(K(w_0 \lambda)) \mid (k_\ell, \dots, k_1) \in \mathbb{Z}_{\geq 0}^\ell\} \setminus \{0\}. \end{aligned}$$

In other words, the opposite Demazure crystal $\mathfrak{B}^{w_0 v}$ is the image of \mathfrak{B}_v (18) by the Schützenberger-Lusztig ξ involution. Recall, if $b \in \mathfrak{B}_v$ then $b = f_{i_\ell}^{k_\ell} \cdots f_{i_1}^{k_1}(K(\lambda))$ and

$$\xi(b) = e_{\theta(i_\ell)}^{k_\ell} \cdots e_{\theta(i_1)}^{k_1}(K(w_0 \lambda)) = \text{evac}(b).$$

Therefore

$$\begin{aligned} \mathfrak{B}^{w_0 v} &= \{e_{\theta(i_\ell)}^{k_\ell} \cdots e_{\theta(i_1)}^{k_1}(K(w_0 \lambda)) \mid (k_\ell, \dots, k_1) \in \mathbb{Z}_{\geq 0}^\ell\} \setminus \{0\} \\ (19) \quad &= \xi(\mathfrak{B}_v) \\ &= \xi\{b \in \mathfrak{B}(\lambda) : K^+(b) \leq K(v)\} \\ &= \{b \in \mathfrak{B}(\lambda) : K^+(\xi b) \leq K(v)\} \\ &= \{b \in \mathfrak{B}(\lambda) : \xi K^-(b) \leq K(v)\} \\ &= \{b \in \mathfrak{B}(\lambda) : K^-(b) \geq \xi K(v)\} \\ &= \{b \in \mathfrak{B}(\lambda) \mid K^-(b) \geq K(w_0 v)\}. \end{aligned}$$

and

$$(20) \quad \mathfrak{B}^v = \xi(\mathfrak{B}_{w_0 v}) = \{b \in \mathfrak{B}(\lambda) : K^-(b) \geq K(v)\}.$$

In particular, since $\mathfrak{B}^\sigma(\lambda) = \xi \mathfrak{B}_{w_0 \sigma}(\lambda)$ then $\mathfrak{B}^e(\lambda) = \xi(\mathfrak{B}_{w_0}(\lambda))$.

Remark 3.17. (1) In types A and C the Schützenberger evacuation algorithm is a realization of the Schützenberger-Lusztig involution on $\mathcal{SSYT}(\lambda, n)$ respectively $\mathcal{KN}(\lambda, n)$ [45, Algorithm 59]. In type C_n the tableau weights in \mathfrak{B}_v and in \mathfrak{B}^{-v} are symmetric.

(2) The Lusztig-Schützenberger involution can be considered, apart the sign of the weights, to take $\mathfrak{B}(\lambda)$ to its dual $\mathfrak{B}(\lambda)^\vee$ as it sends f_i to $e_{\theta(i)}$, and, in particular, we may view the opposite Demazure crystal $\mathfrak{B}^{w_0 \sigma}(\lambda)$ as the dual of the Demazure crystal $\mathfrak{B}_\sigma(\lambda)$. In general, we may view $\mathfrak{B}(\lambda)^\vee = \mathfrak{B}_{w_0}(\lambda)^\vee$ as $\mathfrak{B}(-w_0 \lambda)$.

From (18), (19) and because ξ is an involution, we define the *opposite Demazure crystal atom* $\overline{\mathfrak{B}}^{w_0 v}$ to be

$$(21) \quad \mathfrak{B}^{w_0 v} = \bigsqcup_{v' \in W\lambda, v' \leq v} \xi(\overline{\mathfrak{B}}_{v'}) = \bigsqcup_{v' \in W\lambda, v' \leq v} \overline{\mathfrak{B}}^{w_0 v'} = \bigsqcup_{v' \in W\lambda, v' \geq w_0 v} \overline{\mathfrak{B}}^{v'}.$$

From (21), (20) and (17), one has

$$(22) \quad \begin{aligned} \overline{\mathfrak{B}}^{w_0v} &= \{b \in \mathfrak{B}(\lambda) : K^-(b) = K(w_0v)\} = \xi(\overline{\mathfrak{B}}_v) \\ &\Leftrightarrow \overline{\mathfrak{B}}^v = \{b \in \mathfrak{B}(\lambda) : K^-(b) = K(v)\} = \xi(\overline{\mathfrak{B}}_{w_0v}). \end{aligned}$$

Every opposite Demazure crystal atom contains exactly one key tableau. The left key map sends each tableau to the key tableau in the opposite Demazure crystal atom that contains the tableau.

3.6.3. Relations among Demazure crystals.

Proposition 3.18. *Let $u, v, x, y \in W\lambda$ and $b \in \mathfrak{B}(\lambda)$. Then*

- (1) [21, Chapitre 8] $K^-(b) \leq K^+(b)$ and $K^-(b) = K^+(b) \Leftrightarrow b$ is a key tableau in $O(\lambda)$.
- (2) $\mathfrak{B}_x \subseteq \mathfrak{B}_y \Leftrightarrow \mathfrak{B}^x \supseteq \mathfrak{B}^y \Leftrightarrow x \leq y$.
- (3) $\overline{\mathfrak{B}}^u \cap \overline{\mathfrak{B}}_v \neq \emptyset \Leftrightarrow u \leq v$ which happens when

$$\overline{\mathfrak{B}}^u \cap \overline{\mathfrak{B}}_v = \{b \in B(\lambda) \mid K(u) = K^-(b) \leq K^+(b) = K(v)\} \supseteq \{K(u), K(v)\}.$$

In particular, $\overline{\mathfrak{B}}^v \cap \overline{\mathfrak{B}}_v = \{K(v)\}$ and $\overline{\mathfrak{B}}^v \cap \overline{\mathfrak{B}}_{w_0v} \neq \emptyset$.

- (4) [22, Proposition 4.4] $\mathfrak{B}^u \cap \mathfrak{B}_v \neq \emptyset \Leftrightarrow u \leq v$ which happens when

$$\mathfrak{B}^u \cap \mathfrak{B}_v = \{b \in B(\lambda) \mid K(u) \leq K^-(b) \leq K^+(b) \leq K(v)\} \supseteq \{K(z) \mid z \in [u, v]\},$$

where $[u, v] \subseteq W$ is an interval in the Bruhat order. In particular, $\mathfrak{B}^v \cap \mathfrak{B}_v = \{K(v)\}$.

Proof. (1) From Theorem 3.8, [21, Chapitre 8], $K^-(b) = K^+(b) = K(z)$, for some $z \in W\lambda$, then $b = K(z)$.

- (2) Assuming $x \leq y \Leftrightarrow \mathfrak{B}_x \subseteq \mathfrak{B}_y$ then since ξ is an involution

$$\begin{aligned} \mathfrak{B}_x \subseteq \mathfrak{B}_y &\Leftrightarrow x \leq y \Leftrightarrow w_0x \geq w_0y \Leftrightarrow \mathfrak{B}_{w_0x} \supseteq \mathfrak{B}_{w_0y} \\ &\Leftrightarrow \xi(\mathfrak{B}_{w_0x}) \supseteq \xi(\mathfrak{B}_{w_0y}) \Leftrightarrow \mathfrak{B}^x \supseteq \mathfrak{B}^y. \end{aligned}$$

It remains to prove $\mathfrak{B}_x \subseteq \mathfrak{B}_y \Rightarrow x \leq y$. Let $\mathfrak{B}_x \subseteq \mathfrak{B}_y$. From (17),

$$\overline{\mathfrak{B}}_x = \{b \in \mathfrak{B}(\lambda) : K^+(b) = K(x)\} \subseteq \mathfrak{B}_x \subseteq \mathfrak{B}_y.$$

Since, for $b \in \mathfrak{B}(\lambda)$, $K^+(b)$ is uniquely determined, then from (18), for $b \in \overline{\mathfrak{B}}_x \subseteq \mathfrak{B}_y$, $K^+(b) = K(x) \leq K(y) \Leftrightarrow x \leq y$.

(3) From (22) and (17), $\overline{\mathfrak{B}}^u = \{b \in B(\lambda) : K^-(b) = K(u)\}$, and $\overline{\mathfrak{B}}_v = \{b \in B(\lambda) : K^+(b) = K(v)\}$. Therefore,

$$\overline{\mathfrak{B}}^u \cap \overline{\mathfrak{B}}_v = \{b \in B(\lambda) \mid K(u) = K^-(b) \leq K^+(b) = K(v)\} \neq \emptyset \Leftrightarrow u \leq v.$$

- (4) From (22), (17) and Assertion 3,

$$\begin{aligned} \mathfrak{B}^u \cap \mathfrak{B}_v &= \bigsqcup_{u' \in W\lambda, u' \geq u} \overline{\mathfrak{B}}^{u'} \cap \bigsqcup_{v' \in W\lambda, v' \leq v} \overline{\mathfrak{B}}_{v'} \\ &= \bigsqcup_{\substack{u', v' \in W\lambda, \\ u \leq u' \leq v' \leq v}} \overline{\mathfrak{B}}^{u'} \cap \overline{\mathfrak{B}}_{v'} \\ &= \bigsqcup_{[u', v'] \subset [u, v]} \overline{\mathfrak{B}}^{u'} \cap \overline{\mathfrak{B}}_{v'} \\ &= \{b \in B(\lambda) \mid K(u) \leq K^-(b) \leq K^+(b) \leq K(v)\}. \end{aligned}$$

Therefore, $\mathfrak{B}^u \cap \mathfrak{B}_v \neq \emptyset \Leftrightarrow u \leq v$ which happens when $\mathfrak{B}^u \cap \mathfrak{B}_v \supseteq \{K(z) \mid z \in [u, v]\}$. In particular,

$$\begin{aligned} \mathfrak{B}^v \cap \mathfrak{B}_v &= \overline{\mathfrak{B}}^v \cap \overline{\mathfrak{B}}_v \\ &= \{b \in B(\lambda) : K^-(b) = K(v)\} \cap \{b \in B(\lambda) : K^+(b) = K(v)\} \\ &= \{b \in B(\lambda) : K^-(b) = K(v) = K^+(b)\}, \text{ by assertion (1),} \\ &= \{K(v)\}. \end{aligned}$$

□

Remark 3.19. (1) Note that that assertion (4) is consistent with \mathfrak{B}_v and \mathfrak{B}^u ,

$$\begin{aligned} \mathfrak{B}^\lambda \cap \mathfrak{B}_v &= \{b \in B(\lambda) \mid K(\lambda) \leq K^-(b) \leq K^+(b) \leq K(v)\} \\ &= \{b \in B(\lambda) \mid K^+(b) \leq K(v)\} = \mathfrak{B}_v. \end{aligned}$$

(2)

$$\begin{aligned} \mathfrak{B}^u \cap \mathfrak{B}_{w_0\lambda} &= \{b \in B(\lambda) \mid K(u) \leq K^-(b) \leq K^+(b) \leq K(-\lambda)\} \\ &= \{b \in B(\lambda) \mid K(u) \leq K^-(b)\} = \mathfrak{B}^u. \end{aligned}$$

Therefore

Definition 3.20. we define \mathfrak{B}_v^u the u, v -Demazure crystal \mathfrak{B}_v ,

$$(23) \quad \mathfrak{B}_v^u := \mathfrak{B}^u \cap \mathfrak{B}_v = \bigsqcup_{[u', v'] \subset [u, v]} \overline{\mathfrak{B}}^{u'} \cap \overline{\mathfrak{B}}_{v'} = \bigsqcup_{[u', v'] \subset [u, v]} \overline{\mathfrak{B}}_{v'}^{u'}$$

where $\mathfrak{B}_v^\lambda = \mathfrak{B}_v$ and $\mathfrak{B}_{w_0\lambda}^u = \mathfrak{B}^u$, that is, when $u = \lambda$ and $v = w_0\lambda$ we get the Demazure \mathfrak{B}_v and opposite Demazure \mathfrak{B}^u respectively.

Similarly, $\overline{\mathfrak{B}}_v^u$ the u -bounded Demazure atom crystal \mathfrak{B}_v ,

$$(24) \quad \overline{\mathfrak{B}}_v^u := \overline{\mathfrak{B}}^u \cap \overline{\mathfrak{B}}_v.$$

Proposition 3.21. For $u, v, u', v' \in W\lambda$,

$$\overline{\mathfrak{B}}_v^u \subseteq \overline{\mathfrak{B}}_{v'}^{u'} \Leftrightarrow v' \leq v \leq u \leq u'.$$

3.6.4. *Symplectic keys and standard monomial theory for Schubert and Richardson varieties.* Demazure and opposite Demazure crystals and their intersections are in natural correspondence with Schubert, opposite Schubert varieties and Richardson varieties respectively as illuminated in [16] through a polyhedral lens. The similarity between Demazure crystals and Schubert, opposite and Richardson varieties is explained by the classical Borel-Weil theorem. (We refer to [8, 17, 49, 52] for the geometric definitions and properties.) Next we collect bunch of results for the convenience of the reader.

Let G be a semisimple algebraic group over k closed algebraic field, and $T \subseteq G$ a maximal torus. We also fix $T \subseteq B \subseteq G$, B a Borel subgroup of G (a subgroup of G containing a maximal torus). Let B^- be the corresponding opposite Borel subgroup, that is, it is the unique Borel subgroup of G with the property $B \cap B^- = T$. Consider the Bruhat decomposition

$$G = \bigsqcup_{w \in W} BwB = \bigsqcup_{w \in W} B^-wB.$$

The quotient space G/B , called full flag variety, inherits a disjoint finite decomposition into cells (respect. opposite cells)

$$G/B = \bigsqcup_{w \in W} BwB/B = \bigsqcup_{w \in W} B^-wB/B.$$

Let $C_v := BvB/B$ and $C^v := B^-vB/B$. The Schubert variety X_w , respectively the opposite Schubert variety X^w , in G/B are

$$X_w = \bigsqcup_{v \leq w} C_v, \quad X^w = \bigsqcup_{u \geq w} C^u = w_0 X_{w_0 w} \subseteq G/B,$$

where \leq denotes the (strong) Bruhat order on W .

For λ a dominant weight of G , let $L_\lambda = G \times_B k_{-\lambda}$ be the line bundle on G/B associated to the B -character $(-\lambda)$. That is, we consider $k_{-\lambda}$ as a B -module where $b.z = (-\lambda)(b)z$, $z \in k$.

Let $V(\lambda)$ be the Weyl module of highest weight λ . Let $\mathfrak{B}(\lambda)$ be the Kashiwara crystal of highest weight λ and $\mathbf{B}(\lambda)$ be the set of LS paths of shape λ . The crystal of L-S paths $\mathbf{B}(\lambda)$ is isomorphic to the Kashiwara crystal $\mathfrak{B}(\lambda)$. If $\pi = (\tau, \mathbf{a})$ is an LS path of shape λ , the sequence $\tau = (\tau_0, \dots, \tau_r)$ is strictly decreasing in W/W_λ . The initial direction $i(\pi) = \tau_0$, and the ending direction $e(\pi) = \tau_r$ of the path π coincide with the right key respectively left key of the corresponding vertex in the Kashiwara crystal $\mathfrak{B}(\lambda)$.

Following mostly [29], the LS path π in $\mathbf{B}(\lambda)$ is said to be *standard* on a Richardson variety $X_\tau^\kappa = X^\kappa \cap X_\tau$, $\kappa, \tau \in W^\lambda$ if $\kappa \leq e(\pi) \leq i(\pi) \leq \tau$ in the Bruhat order in W^λ . We denote by $\mathbf{B}_\tau^\kappa(\lambda)$ the set of all LS paths of shape λ , *standard* on X_τ^κ . If $\tau = w_0$ (respectively κ) in W^λ (respectively *id*), then τ (respectively κ) will be omitted and we will write just $\mathbf{B}^\kappa(\lambda) = \{\pi \in \mathbf{B}(\lambda) : e(\pi) \geq \kappa\}$, called opposite Demazure crystal, the set of all L-S paths of shape λ , *standard* on the opposite Schubert variety X^κ (respectively $\mathbf{B}_\tau(\lambda) = \{\pi \in \mathbf{B}(\lambda) : i(\pi) \leq \tau\}$ called the Demazure crystal, the set of all L-S paths of shape λ , *standard* on the Schubert variety X_τ). Therefore $\mathbf{B}_\tau^\kappa(\lambda) = \mathbf{B}_\tau \cap \mathbf{B}^\kappa(\lambda)$. In the Kashiwara crystal this is equivalent to say that $b \in \mathfrak{B}(\lambda)$ is *standard* on the Richardson variety X_τ^κ if $\kappa \leq K^-(b) \leq K^+(b) \leq \tau$ which means $b \in \mathfrak{B}_\tau^\kappa(\lambda) = \mathfrak{B}^\kappa \cap \mathfrak{B}_\tau(\lambda)$.

The space of global sections $H^0(G/B, L_\lambda)$ as a G -module is (isomorphic to) the dual of the module $V(\lambda)$,

$$H^0(G/B, L_\lambda) \simeq V(\lambda)^*.$$

Associated to the combinatorial LS path model $B(\lambda)$ of LS paths of shape λ we have the *path vector basis*

$$\mathbb{B}(\lambda) = \{p_\tau : \tau \in \mathbf{B}(\lambda)\} \subseteq H^0(G/B, L_\lambda) = V(\lambda)^*.$$

It is shown that $\mathbb{B}(\lambda)$ is compatible with Schubert and opposite Schubert varieties $Z \subseteq G/B$, that is, the set $\{b|_Z : b \in \mathbb{B}(\lambda), b|_Z \neq 0\}$ is linearly independent; $\mathbb{B}(\lambda)$ satisfies certain quadratic relations similar to the quadratic straightening. For $G = GL_n(\mathbb{C}), Sp(2n, \mathbb{C})$, associated to the combinatorial tableau model corresponding to the Kashiwara crystal $\mathfrak{B}(\lambda)$, a basis with the same properties has been constructed, in each case. For $GL_n(\mathbb{C})$ see [43, 49] and [17, Chapter III], for instance. For $G = Sp(2n, \mathbb{C})$ one has De Concini's construction [14] for $V(\lambda)$.

For $\tau \in W/W_\lambda$ let $v_\tau \in V(\lambda)$ be a extremal weight vector of weight $\tau.\lambda$. The B -submodule spanned by the orbit $B.v_\tau$ is the Demazure module $V_\tau(\lambda)$ associated to τ . The B^- submodule spanned by the orbit $B^-.v_\tau$ is the opposite Demazure module $V_\tau(\lambda)$ associated to τ .

Proposition 3.22. [29] *The path vector basis $\mathbb{B}(\lambda)$ is compatible with the Demazure submodules, i.e., the restrictions $\{p_\pi|_{V_\tau(\lambda)^*} | \pi \in B_\tau(\lambda)\}$ form a basis of $V_\tau(\lambda)^*$, and the restrictions of the other path vectors ($\pi \notin B_\tau(\lambda)$) vanish on the submodule. Similarly, the restrictions $\{p_\pi|_{V^\tau(\lambda)^*} | \pi \in B^\tau(\lambda)\}$ form a basis of $V^\tau(\lambda)^*$ and the restrictions of the other path vectors ($\pi \notin B^\tau(\lambda)$) vanish.*

Further, the restriction of the section $p_\pi \in \mathbb{B}(\lambda)$ to X_τ vanishes if and only if $i(\pi) \not\leq \tau$. The set of path vectors $\{p_\pi \in \mathbb{B}(\lambda) : i(\pi) \leq \tau\} = \{p_\pi : \pi \in B_\tau(\lambda)\}$ forms a basis of $H^0(X_\tau, L_\lambda) = V_\tau(\lambda)^$. Similarly, the set of path vectors $\{p_\pi \in \mathbb{B}(\lambda) : e(\pi) \geq \tau\}$ forms a basis of $H^0(X^\tau, L_\lambda) = V^\tau(\lambda)^*$.*

The set

$$\mathbb{B}_\tau(\lambda) = \{p_\pi : \pi \in B_\tau(\lambda)\} \subseteq H^0(X_\tau, L_\lambda)$$

and

$$\mathbb{B}^\tau(\lambda) = \{p_\pi : \pi \in B(\lambda)^\tau\} \subseteq H^0(X^\tau, L_\lambda).$$

The set of path vectors $\mathbb{B}_\kappa^\sigma(\lambda) = \{p_\pi : \pi \in B_\kappa^\sigma(\lambda)\}$ form a basis for $H^0(X_\kappa^\sigma, L_\lambda)$.

Corollary 3.23. [29] Let $\mathbb{B}(\lambda)^* = \{u_\pi \in V(\lambda) | \pi \in \mathbb{B}(\lambda)\}$ be the basis of $V(\lambda)$ dual to the path vector basis of $H^0(G/B, L_\lambda)$. The vectors $\{u_\pi | \pi \in B_\tau(\lambda)\}$ form a basis of the Demazure module $V_\tau(\lambda)$, the vectors $\{u_\pi | \pi \in B_\tau(\lambda)\}$ form a basis of the opposite Demazure module $V_\tau(\lambda)$, and the vectors $\{u_\pi | \pi \in B_\tau^\sigma(\lambda)\}$ form a basis of the intersection $V_\tau^\sigma(\lambda) = V_\tau(\lambda) \cap V_\sigma(\lambda)$.

Let π be a LS path of shape λ . The restriction of the section $p_\pi \in \mathbb{B}(\lambda)$ to X_τ vanishes if and only if $i(\pi) \not\leq \tau$. Further, the set of path vectors $\{p_\pi \in \mathbb{B}(\lambda) : i(\pi) \leq \tau\}$ of shape λ forms a basis of $H^0(X_\tau, L_\lambda) = V^*(\lambda)_\tau$.

Corollary 3.24. (1) The following are equivalent

- (a) $\mathbf{B}_x(\lambda) \subseteq \mathbf{B}_y(\lambda) \Leftrightarrow \mathbf{B}^x(\lambda) \supseteq \mathbf{B}^y(\lambda)$.
- (b) $V_x(\lambda)^* \subseteq V_y(\lambda)^* \Leftrightarrow V^x(\lambda)^* \supseteq V^y(\lambda)^*$.
- (c) $x \leq y$.

(2) The following are equivalent

- (a) $\mathbf{B}_\tau^\sigma(\lambda) \neq \emptyset$.
- (b) $V_\tau^\sigma(\lambda) = V_\tau(\lambda) \cap V_\sigma(\lambda) \neq \{0\}$
- (c) $\sigma \leq \tau$

For $w \in W/W_\lambda$, the space of global sections $H^0(X_w, L_\lambda)$ ($H^0(X^w, L_\lambda)$ as a B^- -module) is isomorphic to $V_w(\lambda)^*$ ($V^w(\lambda)^*$) the dual of the Demazure module $V_w(\lambda)$ (the opposite Demazure module $V^w(\lambda)$),

$$H^0(X_w, L_\lambda) \simeq V_w(\lambda)^*, \quad (H^0(X^w, L_\lambda) \simeq V^w(\lambda)^*).$$

In particular, $X_{w_0} = X^{id} = G/B$ and $V_{w_0}(\lambda) = V^{id}(\lambda) = V(\lambda)$.

Facts on Schubert varieties

Proposition 3.25.

For $w, w' \in W/W_\lambda$, the following are equivalent

- (1) $X_w \subseteq X_{w'}$.
- (2) $X^w \supseteq X^{w'}$
- (3) $X^w \cap X^{w'} \neq \emptyset$
- (4) $w \leq w'$

For $\alpha, \beta, \alpha', \beta'$, the following are equivalent

- (1) $X_\alpha^\beta \subseteq X_{\alpha'}^{\beta'}$
- (2) $\beta' \leq \beta \leq \alpha \leq \alpha'$
- (3) $[\beta, \alpha] \subseteq [\beta', \alpha']$

By the Bore-Weil theorem, similar facts on Demazure crystals

Proposition 3.26.

For $w, w' \in W/W_\lambda$, the following are equivalent

- (1) $\mathfrak{B}_w(\lambda) \subseteq \mathfrak{B}_{w'}(\lambda)$.
- (2) $\mathfrak{B}^w(\lambda) \supseteq \mathfrak{B}^{w'}(\lambda)$
- (3) $\mathfrak{B}^w(\lambda) \cap \mathfrak{B}^{w'}(\lambda) \neq \emptyset$
- (4) $w \leq w'$

For $\alpha, \beta, \alpha', \beta'$, the following are equivalent

- (1) $B_\alpha^\beta(\lambda) \subseteq \mathfrak{B}_{\alpha'}^{\beta'}(\lambda)$
- (2) $\beta' \leq \beta \leq \alpha \leq \alpha'$
- (3) $[\beta, \alpha] \subseteq [\beta', \alpha']$

3.7. Demazure characters and opposite Demazure characters and interval Demazure characters. The Demazure characters, or key polynomials, and Demazure atoms can be seen as generating functions of the tableaux in Demazure crystals. Given $v \in B_n \lambda = [\lambda, -\lambda]$:

$$\kappa_v(x_1, \dots, x_n) = \sum_{T \in \mathfrak{B}_v} x^{\text{wt}T}, \quad \bar{\kappa}_v(x_1, \dots, x_n) = \sum_{T \in \overline{\mathfrak{B}}_v} x^{\text{wt}T},$$

and we can define, analogously, opposite Demazure characters and opposite Demazure atoms:

$$\kappa^{-v}(x_1, \dots, x_n) = \sum_{T \in \mathfrak{B}^{-v}} x^{\text{wt}T}, \quad \bar{\kappa}^{-v}(x_1, \dots, x_n) = \sum_{T \in \overline{\mathfrak{B}}^{-v}} x^{\text{wt}T}.$$

Since the tableau weights in \mathfrak{B}_v and in \mathfrak{B}^{-v} (19) are symmetric in \mathbb{Z}^n ,

$$\kappa^{-v}(x_1, \dots, x_n) = \sum_{T \in \mathfrak{B}^{-v}} x^{\text{wt}T} = \sum_{T \in \mathfrak{B}_v} x^{-\text{wt}T} = \sum_{T \in \mathfrak{B}_v} (x^{-1})^{\text{wt}T} = \kappa_v(x_1^{-1}, \dots, x_n^{-1})$$

we have the following result:

Corollary 3.27.

$$\kappa_v(x_1, \dots, x_n) = \kappa^{-v}(x_1^{-1}, \dots, x_n^{-1})$$

As a consequence, for instance, the type C_n Fu-Lascoux non-symmetric Cauchy kernel, given in [15], can be written as:

$$\begin{aligned} \frac{\prod_{1 \leq i < j \leq n} (1 - x_i x_j)}{\prod_{i,j=1}^n (1 - x_i y_j) \prod_{i,j=1}^n (1 - x_i / y_j)} &= \sum_{v \in \mathbb{N}^n} \bar{\kappa}_v(x_1, \dots, x_n) \kappa_{-v}(y_1, \dots, y_n) \\ &= \sum_{v \in \mathbb{N}^n} \bar{\kappa}_v(x_1, \dots, x_n) \kappa^\nu(y_1^{-1}, \dots, y_n^{-1}) \end{aligned}$$

equivalently, putting $\mathbf{x} = (x_1, \dots, x_n)$ and $\mathbf{y}^{-1} = (y_1^{-1}, \dots, y_n^{-1})$,

$$(25) \quad \prod_{1 \leq i, j \leq n} (1 - x_i y_j)^{-1} \prod_{1 \leq i \leq j \leq n} (1 - x_i y_j^{-1})^{-1} = \sum_{\nu \in \mathbb{N}^n} \bar{\kappa}_\nu(\mathbf{x}) \kappa^{\nu^C}(\mathbf{y}) \left(\sum_{\beta' \text{ even}} s_\beta(\mathbf{x}) \right),$$

See also [13, 2] for type A non-symmetric Cauchy kernels [2].

The Demazure character interval

$$\kappa_v^u(x_1, \dots, x_n) = \sum_{T \in \mathfrak{B}_v^u} x^{\text{wt}T} = \sum_{K(u) \leq K^-(T) \leq K^+(T) \leq K(v)} x^{\text{wt}T}, \quad \bar{\kappa}_v^u(x_1, \dots, x_n) = \sum_{T \in \overline{\mathfrak{B}}_v^u} x^{\text{wt}T}$$

4. COCRYSTAL OF A KN TABLEAU

Motivated by Lascoux's double crystal graph construction in type A [32], and by Heo-Kwon work in [18] where Schützenberger *jeu de taquin* slides are used as crystal operators for \mathfrak{sl}_2 , the cocrystal of each KN tableau in the type C_n crystal $\mathfrak{B}(\lambda)$ is introduced. These cocrystals contain all the needed information to compute right and left keys of a tableau in the type C_n crystal $\mathfrak{B}(\lambda)$ and refine previous second author's construction of symplectic key maps in [45] based on the symplectic *jeu de taquin*.

4.1. Dual RSK correspondence. In this subsection we work with semistandard Young tableaux. Given a tableau $T \in \mathcal{SSYT}(\lambda, n)$ with column decomposition $T = C_1 C_2 \cdots C_k$, its *column reading word*, $\text{cr}(T)$, is the word obtained after concatenating all of its column readings $\text{cr}(C_i)$ from right to left: $\text{cr}(T) := \text{cr}(C_k) \cdots \text{cr}(C_2) \text{cr}(C_1)$ where $\text{cr}(C_i)$ is the word obtained reading the column C_i top to bottom.

Example 4.1. Given $T = \begin{array}{|c|c|c|} \hline 1 & 2 & 2 \\ \hline 2 & 3 & \\ \hline 4 & 4 & \\ \hline \end{array} \in \mathcal{SSYT}((3, 2, 2, 0), 4)$, the column reading of T is $\text{cr}(T) = 2\,2\,3\,4\,1\,2\,4$.

Given a column reading word w , we can recover the original tableau via *column insertion* [17]: Let $w = w_1 \cdots w_\ell$. We start with $i := 1$, $T = \emptyset$, the empty tableau, and $p = 1$.

- (1) If w_i is bigger than all entries of C_p , just add a cell to the bottom column C_p with entry w_i . Else find $\alpha \in C_p$ the smallest entry of C_p bigger or equal than w_i . Then replace α by w_i in C_p and redefine $w_i := \alpha$, $p := p + 1$ and go to (2) (this is called a *bumping*).
- (2) If $i \neq \ell$, then $i := i + 1$ and go to (1). Else the algorithm ends.

Given $r \geq 1$, let E_n^r be the set of bi-words, two rowed arrays, $w = \begin{pmatrix} u_1 \cdots u_r \\ v_1 \cdots v_r \end{pmatrix}$ without repeated bi-letters, in lexicographic order,

$$\begin{pmatrix} u_i \\ v_i \end{pmatrix} \leq \begin{pmatrix} u_{i+1} \\ v_{i+1} \end{pmatrix} \text{ if } u_i < u_{i+1} \text{ or if } u_i = u_{i+1} \text{ and } v_i \leq v_{i+1},$$

where the bottom word $v_1 \cdots v_r$ of w is in the alphabet $[n]$, and the top word $u_1 \cdots u_r$ of w is in the alphabet $[r]$.

The set E_n^r can also be thought as the set of sequences of r columns, possibly some of them empty, on the alphabet $[n]$, where each pair of consecutive columns has maximum overlapping, and, in the case of two non-empty columns whose intermediate columns are empty, the top edge of the left column and the bottom edge of the right column are aligned. That is, in this representation a bi-word $w = \begin{pmatrix} u \\ v \end{pmatrix}$ in E_n^r is a semistandard skew tableau T in the alphabet $[n]$, whose *column reading word is the bottom word in the bi-word*, $\text{cr}(T) = v$, with at most r columns such that column i , counted right to left, is filled with all bottom letters in the bi-letters whose top letter is i , and each pair of consecutive columns C_{i+1} and C_i form a skew semistandard tableau where the number of rows of length two is maximized. This means that the *sequence of column lengths, right to left, is equal to the weight of the top word u in the bi-word*. For instance,

$$\begin{array}{|c|c|c|} \hline & & 2 \\ \hline & & 3 \\ \hline 1 & 2 & 4 \\ \hline 2 & & \\ \hline 4 & & \\ \hline \end{array} \quad \text{and} \quad \begin{pmatrix} 1 & 1 & 1 & 2 & 3 & 3 & 3 \\ 2 & 3 & 4 & 2 & 1 & 2 & 4 \end{pmatrix} \text{ are identified in } E_4^3.$$

In particular, E_n^r has a subset identified with $\bigsqcup_{\substack{\ell(\lambda) \leq n \\ \ell(\lambda') \leq r}} \mathcal{SSYT}(\lambda, n)$ where $\ell(\lambda')$ is the length of λ' , the conjugate partition of λ . Given a tableau $T \in \mathcal{SSYT}(\lambda, n)$, we create a bi-word, without repeated bi-letters, whose bottom word is $\text{cr}(T)$ and in the top word we register in which column of T , counted from the right, was each letter of $\text{cr}(T)$ read. Each biword will be an element of E_n^r , where $\ell(\lambda') \leq r$. In Example 4.1, the bi-word of T is

$$w = \begin{pmatrix} 1 & 2 & 2 & 2 & 3 & 3 & 3 \\ 2 & 2 & 3 & 4 & 1 & 2 & 4 \end{pmatrix} \in E_4^3, \text{ with } \ell(\lambda') = 3.$$

The dual RSK, RSK^* , is a bijection [17, Section A.4.3] between E_n^r and pairs of SSYT's of conjugate shapes and lengths $\leq n$ and $\leq r$, respectively:

$$RSK^* : E_n^r \rightarrow \bigsqcup_{\substack{\ell(\lambda) \leq n \\ \ell(\lambda') \leq r}} \mathcal{SSYT}(\lambda, n) \times \mathcal{SSYT}(\lambda', r) = \bigsqcup_{\substack{\ell(\lambda) \leq n \\ \ell(\lambda') \leq r \\ P \in \mathcal{SSYT}(\lambda, n)}} \{P\} \times \mathcal{SSYT}(\lambda', r)$$

$$w \mapsto (P, Q).$$

The bijection RSK^* can be calculated in the following way:

Let $w = \begin{pmatrix} x_1 & x_2 & \dots & x_m \\ y_1 & y_2 & \dots & y_m \end{pmatrix}$. Then start with $i = 1$ and $P = Q$ empty tableaux.

- (1) Column insert y_i into P .
- (2) Add one cell to Q whose entry is x_i , in a position such that P and Q , with this new cell, have conjugate shapes.
- (3) If $i \neq m$, then $i := i + 1$ and return to (1). Else the algorithm is finished.

Given a bi-word w , the first and second components of $RSK^*(w)$ are called the P -symbol and the Q -symbol of w respectively.

The RSK^* maps the bi-word of a skew SSYT \tilde{T} in the alphabet $[n]$ with at most r columns, to $(\text{rect}(\tilde{T}), Q)$ where $\text{rect}(\tilde{T})$ is the rectification of \tilde{T} via SJDT, and the weight of Q is the sequence of column lengths of \tilde{T} from right to left.

Example 4.2. Let $\tilde{T} = \begin{array}{|c|c|c|} \hline & & 2 \\ \hline 1 & 2 & 3 \\ \hline 2 & 4 & \\ \hline 4 & & \\ \hline \end{array}$ be a SSYT. Its biword is $\tilde{w} = \begin{pmatrix} 1 & 1 & 2 & 2 & 3 & 3 & 3 \\ 2 & 3 & 2 & 4 & 1 & 2 & 4 \end{pmatrix}$, and

$$RSK^*(\tilde{w}) = \left(\text{rect}(\tilde{T}), \tilde{Q} = \begin{array}{|c|c|c|} \hline 1 & 1 & 2 \\ \hline 2 & 3 & 3 \\ \hline 3 & & \\ \hline \end{array} \right).$$

The weight of \tilde{Q} , $\text{wt}(\tilde{Q}) = (2, 2, 3)$ is the sequence of column lengths of \tilde{T} from right to left.

Example 4.3. The bi-word $w = \begin{pmatrix} 1 & 2 & 2 & 2 & 3 & 3 & 3 \\ 2 & 2 & 3 & 4 & 1 & 2 & 4 \end{pmatrix}$ of $T \in \mathcal{SSYT}((3, 3, 2), 4)$, in Example 4.1, is mapped to the pair

$$\left(T = \begin{array}{|c|c|c|} \hline 1 & 2 & 2 \\ \hline 2 & 3 & \\ \hline 4 & 4 & \\ \hline \end{array}, K(\text{rev}(3, 2, 2)') = \begin{array}{|c|c|c|} \hline 1 & 2 & 2 \\ \hline 2 & 3 & 3 \\ \hline 3 & & \\ \hline \end{array} \right)$$

where $\lambda' = (3, 3, 1)$, $\text{rev } \lambda' = (1, 3, 3)$.

More generally, given $T \in \mathcal{SSYT}(\lambda, n)$ with $\ell(\lambda') \leq r$, the dual RSK maps the bi-word presentation of T , to the pair $(T, K(\text{rev}(\lambda')))$, where $\text{rev}(\lambda')$ is the vector λ' written backwards. Note that in this case Q is of shape λ' and its weight records the column lengths of T , from right to left. That is, Q is of shape λ' and its weight, $\text{wt}(Q) = \text{rev } \lambda'$, henceforth $Q = K(\text{rev } \lambda')$.

4.2. Cocystal of SSYT's. Given $T \in \mathcal{SSYT}(\lambda, n)$ with $\ell(\lambda') \leq r$, we define the *cocystal* of T , $\mathfrak{CB}^{\lambda'}(T)$, to be the \mathfrak{gl}_r -crystal,

$$(26) \quad \mathfrak{CB}^{\lambda'}(T) = (\text{RSK}^*)^{-1}(\{T\} \times \mathcal{SSYT}(\lambda', r)) \subseteq E_n^r,$$

where the lowering \mathcal{F}_i and raising \mathcal{E}_i crystal operators, are SJDT slides on consecutive columns i , $i + 1$ on each element of $\mathfrak{CB}^{\lambda'}(T)$, for $i = 1, \dots, r - 1$, right to left. More precisely, $\mathcal{F}_i(\mathcal{E}_i)$, when defined, sends a cell from the i ($i + 1$)-th column to the $i + 1$ (i)-th column. The weight map in

$\mathfrak{CB}^{\lambda'}(T)$ maps each element \tilde{T} to the sequence of its column lengths from right to left, $\text{wt}(\tilde{T}) =$ reverse sequence of column lengths of \tilde{T} ; and for $X \in \mathfrak{CB}^{\lambda'}(T)$ if $\mathcal{F}_i(X) = Y$ we also have $\text{wt}(Y) = \text{wt}(X) - \alpha_i$, with $\alpha_i = e_i - e_{i+1}$, $i = 1, \dots, r-1$, the simple roots of type A_{r-1} . The cocrystal of T is a highest weight crystal with highest weight $\text{rev}\lambda'$, and highest element the anti-rectification of T , $\text{arect}(T)$, that is, the rectification on T is performed south-eastward,

$$\begin{aligned} \mathfrak{CB}^{\lambda'}(T) &= \{ \mathcal{F}_{i_k}^{m_{i_k}} \cdots \mathcal{F}_{i_1}^{m_{i_1}}(\text{arect}(T)) \mid (m_{i_k}, \dots, m_{i_1}) \in \mathbb{Z}_{\geq 0}^k, k \geq 0 \} \setminus \{0\} \\ &= \{ \mathcal{E}_{i_k}^{m_{i_k}} \cdots \mathcal{E}_{i_1}^{m_{i_1}}(T) \mid (m_{i_k}, \dots, m_{i_1}) \in \mathbb{Z}_{\geq 0}^k, k \geq 0 \} \setminus \{0\}, \end{aligned}$$

where T is the lowest weight element of $\mathfrak{CB}^{\lambda'}(T)$. The type A_{r-1} crystals $\mathcal{SSYT}(\lambda', r)$ and $\mathfrak{CB}^{\lambda'}(T)$ are isomorphic via the map

$$(27) \quad \mathfrak{CB}^{\lambda'}(T) \rightarrow \mathcal{SSYT}(\lambda', r), \quad \tilde{T} \mapsto Q(\tilde{T})$$

such that $RSK^*(\tilde{T}) = (T, Q(\tilde{T}))$ and $\text{wt}(\tilde{T}) = \text{wt}(Q(\tilde{T}))$. This crystal isomorphism relies on the following proposition, a consequence of [18, Lemma 2.3, Lemma 2.4] by Heo-Kwon:

Proposition 4.4. *Let X be a skew SSYT. The Q -symbol of $\mathcal{F}_i(X)$ is the same as f_i applied to the Q -symbol of X , $Q(\mathcal{F}_i(X)) = f_i Q(X)$ (similarly for \mathcal{E}_i and e_i), and the weight of the Q -symbol of X records the column lengths of X from right to left.*

Example 4.5. Recall T in Example 4.3 and \tilde{T} in Example 4.2. Note that $T = \mathcal{F}_1(\tilde{T})$ and that the Q -symbols obtained from both tableaux via the map (27) are connected via f_1 , that is, $Q(T) = K(\text{rev}(3, 2, 2)') = f_1 Q(\tilde{T}) = Q(\mathcal{F}_1(\tilde{T}))$. See Figure 6.

On the right hand side of Figure 6, we have the cocrystal $\mathfrak{CB}^{\lambda'}(T)$, whose vertices are obtained by applying the elementary SJDT slides \mathcal{E}_i , for $i = 1, 2$, on T , the lowest weight element of the cocrystal $\mathfrak{CB}^{\lambda'}(T)$. Namely, \mathcal{E}_1 sends an entry from the second column to the first column, and \mathcal{E}_2 sends an entry from the third column to the second column, where we count columns starting from the right. \mathcal{F}_1 and \mathcal{F}_2 are the inverse operations.

On the left hand side, we have the type A_2 crystal $\mathcal{SSYT}((3, 3, 1), 3)$, formed by the Q -symbols of every skew tableau that exists in the type A_2 crystal $\mathfrak{CB}^{\lambda'}(T)$ on the right. The type A_2 crystal operators on the left are defined by the signature rule on the alphabet [3], whereas, on the right, \mathcal{F}_1 and \mathcal{F}_2 are type A_2 crystal operators defined by SJDT on adjacent columns.

4.3. Cocrystal of KN tableaux. Let $T \in \mathcal{SSYT}(\lambda, n)$. Note that T , the lowest weight of the cocrystal $\mathfrak{CB}^{\lambda'}(T)$, is also in the type C_n crystal $\text{KN}(\lambda)$ (recall that $\mathcal{SSYT}(\lambda, n)$ is a subcrystal of $\text{KN}(\lambda)$). Fixed an arbitrary tableau Y in the crystal $\text{KN}(\lambda)$, there is a sequence \mathcal{S} of type C_n crystal operators, on $\text{KN}(\lambda)$, such that $\mathcal{S}(T) = Y$. All elements of the cocrystal $\mathfrak{CB}^{\lambda'}(T)$ are SJDT related and we can apply this sequence \mathcal{S} to all skew tableaux in the cocrystal, obtaining, for each skew tableau, a new skew tableau of the same shape. All these skew tableaux, obtained by application of the sequence \mathcal{S} to each element of $\mathfrak{CB}^{\lambda'}(T)$, will be connected via SJDT, because the SJDT and the crystal operators of $\text{KN}(\lambda)$ commute [34, Theorem 6.3.8], hence they are the elements of a new cocrystal $\mathfrak{CB}^{\lambda'}(\mathcal{S}(T))$ of type A_{r-1} , despite that its vertices are type C_n objects (i.e. KN skew tableaux). Recalling that the weight function of $\mathfrak{CB}^{\lambda'}(T)$ is given by the column lengths of each vertex, from right to left, which is preserved by any sequence \mathcal{S} of crystal operators given by the C_n signature rule in $\text{KN}(\lambda)$, the following is a consequence of Proposition 4.4.

Proposition 4.6. *Given $T \in \mathcal{KN}(\lambda, n)$, with $\ell(\lambda') \leq r$, the cocrystal $\mathfrak{CB}^{\lambda'}(T)$ with lowest weight element T , obtained from T by successive application of elementary SJDT moves, is crystal isomorphic to the \mathfrak{gl}_r -crystal $\mathcal{SSYT}(\lambda', r)$.*

As a consequence, interestingly, these elementary SJDT moves \mathcal{E}_i and \mathcal{F}_i in the cocrystal of a KN tableau do not incur in a loss of boxes, that is, the B2 case in the symplectic jeu de taquin never occurs. We have thus for $X \in \mathfrak{CB}^{\lambda'}(T)$, $\mathcal{F}_i(\mathcal{S}(X)) = \mathcal{S}(\mathcal{F}_i(X))$ (similarly for \mathcal{E}_i), and therefore $\mathfrak{CB}^{\lambda'}(T)$ and $\mathfrak{CB}^{\lambda'}(\mathcal{S}(T))$ are A_{r-1} isomorphic crystals. See Figure 7.

Fulton [17] has proved the following result for semistandard tableaux.

Proposition 4.7. [17, Proposition 7, Corollary 1, Appendix A.5] *Given $T \in \mathcal{SSYT}(\lambda, n)$ and a skew shape whose column lengths are a permutation of λ' , the column lengths of T , there is exactly one skew tableau with that shape that rectifies to T . Furthermore, the last and first columns only depend on their lengths.*

This means that given $T \in \mathcal{SSYT}(\lambda, n)$, the cocrystal $\mathfrak{CB}^{\lambda'}(T)$ attached to $T \in \mathcal{SSYT}(\lambda, n)$ has a distinguished set of skew tableaux whose column lengths are a permutation of λ' , the column lengths of T . The skew shapes of these distinguished vertices are preserved by any sequence \mathcal{S} of type C_n crystal operators of the crystal \mathfrak{B}^λ . Thus we obtain another proof of Proposition 40 and Corollary 41 in second author's work [45] which is an extension of the previous Proposition 4.7 to KN tableaux.

Proposition 4.8. [45, Proposition 40, Corollary 41], [44] *Given $T \in \mathcal{KN}(\lambda, n)$ and a skew shape whose column lengths are a permutation of λ' , the column lengths of T , there is exactly one skew tableau with that shape that rectifies to T . Furthermore, the last and first columns only depend on their lengths.*

A key tableau in the type A_{r-1} crystal $\mathcal{SSYT}(\lambda', r)$ is a tableau of shape λ' whose weight is in $\mathfrak{S}_r \lambda'$, the \mathfrak{S}_r -orbit of λ' . For each element of $\mathfrak{S}_r \lambda'$ there is exactly one key tableau of shape λ' with that weight. More precisely the key tableaux in $\mathcal{SSYT}(\lambda', r)$ are the distinguished vertices which define the set $\mathfrak{S}_r K(\lambda')$ where $s_i K(\lambda') = K(s_i \lambda')$ and s_i are the simple transpositions of \mathfrak{S}_r , for $i = 1, \dots, r-1$. Thereby it is natural to define keys in a cocrystal (a type A crystal).

Definition 4.9. Given $T \in \mathcal{KN}(\lambda, n)$, with $\ell(\lambda') \leq r$, and $X \in \mathfrak{CB}^{\lambda'}(T)$, the skew tableau X is said to be a key of $\mathfrak{CB}^{\lambda'}(T)$ if its weight as an element of the said cocrystal, the sequence column lengths of X , from right to left, is a permutation of $rev \lambda'$, the weight of T as an element of the same cocrystal.

In other words, given $T \in \mathcal{KN}(\lambda, n)$, the keys of $\mathfrak{CB}^{\lambda'}(T)$ are the image of the keys in $\mathcal{SSYT}(\lambda', r)$ via the crystal isomorphism (27). We then have an action of the left cosets $\mathfrak{S}_r / \mathfrak{S}_{r, \lambda'}$ on the set of the keys in $\mathfrak{CB}^{\lambda'}(T)$. In Figure 7 the weak Bruhat order on the cosets $\mathfrak{S}_3 / \mathfrak{S}_{3(3,3,1)}$ can be identified with the weak Bruhat order on the keys of the cocrystal $\mathfrak{CB}^{\lambda'}(T)$

$$(28) \quad \mathcal{S}(T) = \begin{array}{|c|c|c|} \hline 1 & 2 & 2 \\ \hline 2 & 3 & \\ \hline 4 & \overline{4} & \\ \hline \end{array} \xrightarrow{\mathcal{E}_1^2} \begin{array}{|c|c|c|} \hline & & 2 \\ \hline & & 3 \\ \hline 1 & 2 & \overline{4} \\ \hline 2 & & \\ \hline & & 4 \\ \hline \end{array} \xrightarrow{\mathcal{E}_2^2} \begin{array}{|c|c|} \hline 1 & 2 \\ \hline 2 & 3 \\ \hline 2 & 4 \\ \hline & \overline{4} \\ \hline \end{array}.$$

Example 4.10. Recall the right hand side crystal in Figure 6. T is in the type C_4 crystal $\mathcal{KN}((3, 2, 2, 0), 4)$. Hence we can apply to each vertex of $\mathfrak{CB}^{\lambda'}(T)$ the sequence of crystal operators $S = f_4$, obtaining a new cocrystal, on the right, whose vertices are KN skew tableaux connected via SJDT. This cocrystal $\mathfrak{CB}^{\lambda'}(f_4(T))$ is a type A_2 crystal. See Figure 7.

The KN tableaux T and $f_4(T)$ are contained in the type C_4 crystal $\mathcal{KN}((3, 3, 2), 4)$ with highest weight element $K(\lambda)$ and lowest weight element $K(-\lambda)$. The KN skew tableaux in a same horizontal position of the cocrystals define a type C_4 crystal isomorphic to the crystal $\mathcal{KN}((3, 3, 2), 4)$. In fact, their highest weight elements are the Littlewood-Richardson tableaux [17] of weight λ , defining the cocrystal attached to $K(\lambda)$, the Yamanouchi tableau of weight and shape λ . For instance, the type

C_4 crystal containing \tilde{T} and $f_4(\tilde{T})$ has highest weight element the Littlewood-Richardson tableau

$$\mathcal{E}_1(K(\lambda)) = \begin{array}{|c|c|c|} \hline & & 1 \\ \hline 1 & 1 & 2 \\ \hline 2 & 3 & \\ \hline 3 & & \\ \hline \end{array}$$

and lowest weight element its reversal (in the sense of Lusztig involution [45]) $\mathcal{E}_1(K(-\lambda)) = \begin{array}{|c|c|c|} \hline & & \bar{3} \\ \hline \bar{3} & \bar{2} & \bar{1} \\ \hline \bar{2} & \bar{1} & \\ \hline \bar{1} & & \\ \hline \end{array}$.

4.4. The Schützenberger-Lusztig involution on a cocrystal. The next lemma will help us relate the cocrystal $\mathfrak{CB}^{\lambda'}(T)$ and the cocrystal $\mathfrak{CB}^{\lambda'}(T^{Ev})$.

Let $\#$ be the map that given a KN tableau T , π -rotates T and replaces each entry with its symmetric. Recall that when $T \in \mathcal{KN}(\lambda, n)$, [45, Algorithm 59],

$$(29) \quad \text{evac}(T) = \text{rect}(T^\#) = (\text{arect}(T))^\#.$$

Lemma 4.11. *Let T be a KN tableau with two columns T_1, T_2 , left to right. Let S be a skew tableau, with two columns S_1, S_2 , obtained from T after π -rotating T and replacing each entry by its symmetric. Let us play the SJDT in both T and S , in T we are sending a cell from T_1 to T_2 and in S we are sending a cell from S_2 to S_1 , obtaining T' and S' , respectively. Then S' is obtained from T' by π -rotating T' and replacing each entry by its symmetric.*

Proof. Let T'_1, T'_2 be the columns of T' and S'_1, S'_2 be the columns of S' . Let $\#$ be the map that given T , π -rotates T and replaces each entry with its symmetric. Then $S = T^\#, S_1 = T_2^\#, S_2 = T_1^\#$, and $\text{spl}(S) = \text{spl}(T)^\#$.

Note that the entry α that gets slid from T_1 to T_2 is symmetric to the entry that gets slid from S_2 to S_1 . So we have two cases:

- If α is positive: $T'_1 = T_1 \setminus \{\alpha\}$, $T'_2 = \Phi^{-1}(\Phi(T_2) \cup \{\alpha\})$, $S'_2 = S_2 \setminus \{\bar{\alpha}\}$, $T'_1 = \Phi^{-1}(\Phi(T_1) \cup \{\bar{\alpha}\})$. So, $S'_1 = T_2'^{\#}$ and $S'_2 = T_1'^{\#}$. Hence $S' = T'^{\#}$.
- If α is negative: $T'_1 = \Phi^{-1}(\Phi(T_1) \setminus \{\alpha\})$, $T'_2 = T_2 \cup \{\alpha\}$, $S'_2 = \Phi^{-1}(\Phi(S_2) \setminus \{\bar{\alpha}\})$, $S'_1 = S_1 \cup \{\bar{\alpha}\}$. So, $S'_1 = T_2'^{\#}$ and $S'_2 = T_1'^{\#}$. Hence $S' = T'^{\#}$.

□

Proposition 4.12. *Let $T \in \mathcal{KN}(\lambda, n)$. If we π -rotate $\mathfrak{CB}^{\lambda'}(T)$, replace each entry by its symmetric, and for every $i \in [n]$, recolour all arrows of colour i with the colour $r - i$ and reverse them, we obtain $\mathfrak{CB}^{\lambda'}(T^{Ev})$.*

Proof. Note that, after doing all the steps in the statement, all the arrows stay intact. Recall the map $\#$ from the previous proof. Schützenberger evacuation, $\text{evac}T = \text{rect}(T^\#)$, implies that $T^\#$ is the highest weight element of $\mathfrak{CB}^{\lambda'}(T^{Ev})$.

Using the previous lemma, we have that, for all $i \in [n]$, $\mathcal{E}_i(T) = \mathcal{F}_{r-i}(T^\#)$. Hence we can prove, recursively, that for every skew tableau $S \in \mathfrak{CB}^{\lambda'}(T)$, we have $S^\# \in \mathfrak{CB}^{\lambda'}(T^{Ev})$ and the position of $S^\#$ in $\mathfrak{CB}^{\lambda'}(T^{Ev})$ can be found if we π -rotate the whole cocrystal. □

Remark 4.13. The last proposition implies that all first of the skew tableaux in $\mathfrak{CB}^{\lambda'}(T)$ are symmetric to all last of the skew tableaux in $\mathfrak{CB}^{\lambda'}(T^{Ev})$. Hence we have that $\text{wt}(K_+(T)) = -\text{wt}(K_-(T^{Ev}))$, and the key tableaux are uniquely described by their weight, we can say that $K_+(T) = K_-(T^{Ev})^{Ev}$. Analogously, we have that $K_-(T) = K_+(T^{Ev})^{Ev}$. This is also proven in [45, Proposition 64].

5. THE RIGHT AND LEFT KEY OF A KN TABLEAU - *Jeu de taquin* APPROACH AND COCRYSTAL

5.1. Right and left key maps and the keys of a cocrystal. Given $T \in \mathcal{KN}(\lambda, n)$, to determine the content of a given column of its right key, $K_+(T)$, we need to compute the right column of a last column, with the same length, of a skew tableau in the cocrystal $\mathfrak{CB}^{\lambda'}(T)$. Analogously, to determine the content of a given column of its left key, $K_-(T)$, we need to compute the left column of a first column, with the same length, of a skew tableau in the cocrystal $\mathfrak{CB}^{\lambda'}(T)$ [45, 44]. Proposition 4.8 ensures that such computation of the right, or left, key of a KN tableau via SJDT is well-defined. The following is a reformulation of [44, Theorem 43] using the concept of cocrystal.

Theorem 5.1. [45],[44, Theorem 43] *Given a KN tableau T , we can replace each column with a column of the same size taken from the right columns of the last columns of all keys in the cocrystal of T . This tableau is the right key tableau of T , $K_+(T)$. If we replace each column of T with a column of the same size taken from the left columns of all keys of the cocrystal of T , we obtain the left key of T , $K_-(T)$.*

The cocrystal keys in (28) give the right and left keys of $S(T)$, $K^+(S(T)) = \begin{array}{|c|c|c|} \hline 2 & 2 & 2 \\ \hline 3 & 3 & \\ \hline 4 & 4 & \\ \hline \end{array}$ and

$$K_-(S(T)) = \begin{array}{|c|c|c|} \hline 1 & 1 & 2 \\ \hline 2 & 2 & \\ \hline 4 & 4 & \\ \hline \end{array}.$$

Hence, the cocrystal $\mathfrak{CB}^{\lambda'}(T)$ contains all the needed information to compute right and left keys. This is explored again in the next section.

Given $T \in \mathcal{KN}(\lambda, n)$, we apply the SJDT on consecutive columns to compute the keys of $\mathfrak{CB}^{\lambda'}(T)$, and, henceforth, all skew tableaux in the conditions of Proposition 4.8.

Example 5.2. The tableau $T = \begin{array}{|c|c|c|} \hline 1 & 3 & \bar{1} \\ \hline 3 & \bar{3} & \\ \hline \bar{3} & & \\ \hline \end{array}$ gives rise to the cocrystal $\mathfrak{CB}^{\lambda'}(T)$, with $\lambda = (3, 2, 1)$. The

following are the vertices of $\mathfrak{CB}^{\lambda'}(T)$ consisting of the six KN skew tableaux with the same number of columns of each length as T , each one corresponding to a permutation of its column lengths.

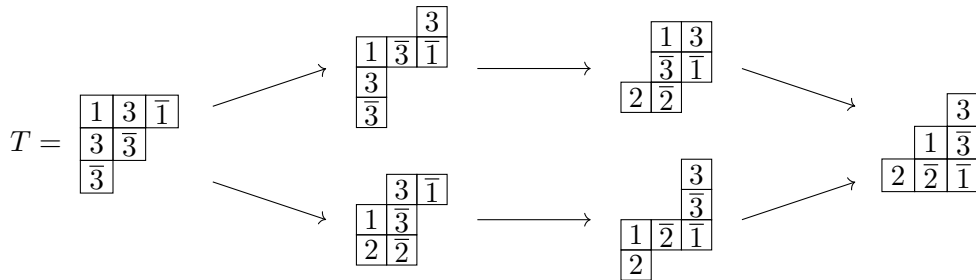

The right key tableau of T has columns $r \begin{array}{|c|} \hline 3 \\ \hline 3 \\ \hline 1 \\ \hline \end{array}$, $r \begin{array}{|c|} \hline 3 \\ \hline 1 \\ \hline \end{array}$ and $r \begin{array}{|c|} \hline 1 \\ \hline \end{array}$. Hence $K_+(T) = \begin{array}{|c|c|c|} \hline 3 & 3 & \bar{1} \\ \hline 2 & \bar{1} & \\ \hline \bar{1} & & \\ \hline \end{array}$. The left

key tableau of T has columns $\ell \begin{array}{|c|} \hline 1 \\ \hline 3 \\ \hline 3 \\ \hline \end{array}$, $\ell \begin{array}{|c|} \hline 1 \\ \hline 2 \\ \hline \end{array}$ and $\ell \begin{array}{|c|} \hline 2 \\ \hline \end{array}$. Hence $K_-(T) = \begin{array}{|c|c|c|} \hline 1 & 1 & 2 \\ \hline 2 & 2 & \\ \hline 3 & & \\ \hline \end{array}$.

To obtain the weak Bruhat graph of the cocrystal keys in $\mathfrak{CB}^\lambda(\text{evac}(T))$, we π -rotate the whole Bruhat graph of the cocrystal keys in $\mathfrak{CB}^\lambda(T)$, π -rotate each co-crystal key and replace each entry by its symmetric. That is, we compute $\xi(\mathfrak{CB}^\lambda(T))$

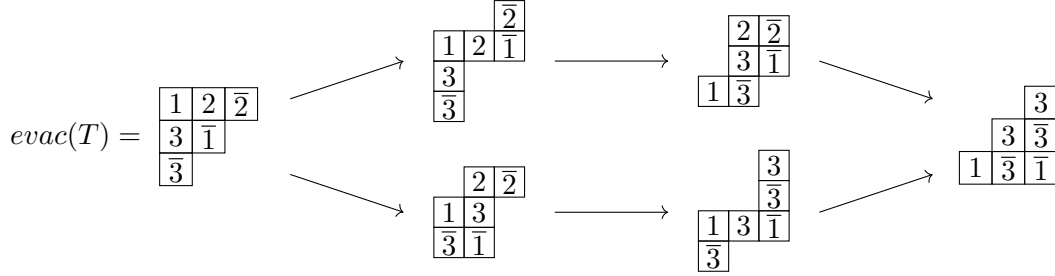

The right key tableau of $\text{evac}T$ has columns $r \begin{smallmatrix} 3 \\ \bar{3} \\ \bar{1} \end{smallmatrix}$, $r \begin{smallmatrix} \bar{2} \\ \bar{1} \end{smallmatrix}$ and $r \begin{smallmatrix} \bar{2} \end{smallmatrix}$. Hence $K_+(\text{evac}T) = \begin{smallmatrix} 3 & \bar{2} & \bar{2} \\ \bar{2} & \bar{1} & \\ \bar{1} & & \end{smallmatrix}$.

The left key tableau of the tableau $\text{evac}T = \begin{smallmatrix} 1 & 3 & \bar{1} \\ 3 & \bar{3} & \\ \bar{3} & & \end{smallmatrix}$ has columns $\ell \begin{smallmatrix} 1 \\ 3 \\ \bar{3} \end{smallmatrix}$, $\ell \begin{smallmatrix} 1 \\ \bar{3} \end{smallmatrix}$ and $\ell \begin{smallmatrix} \bar{1} \end{smallmatrix}$. Hence

$$K_-(\text{evac}T) = \begin{smallmatrix} 1 & 1 & 1 \\ 2 & \bar{3} & \\ \bar{3} & & \end{smallmatrix}.$$

Let $T = C_1 C_2 \cdots C_k$ be a straight KN tableau with columns C_1, C_2, \dots, C_k . Note that, to compute which entries appear in the i -th column of $K_+(T)$ we do not need to look to the first $i - 1$ columns of T . We only need the last column of a skew tableau obtained by applying the SJDT to the columns $C_i \cdots C_k$ of T , so that the last column has the length of C_i , because, by Proposition 4.8, all last columns of skew tableaux associated to T with the same length are equal. Let $K_+^1(T)$ be the map that given a tableau returns the first column of $K_+(T)$. This is noticeable in Example 5.2 where $K_+(T) = K_+^1(C_1 C_2 C_3) K_+^1(C_2 C_3) K_+^1(C_3)$. In general, $K_+(T) = K_+^1(C_1 \cdots C_k) K_+^1(C_2 \cdots C_k) \cdots K_+^1(C_k)$. Based on this observation and Proposition 4.8, next algorithm refines our way to compute $K_+^1(T)$ using SJDT:

Algorithm 5.3. Let T be a straight KN tableau:

- (1) Let $i = 2$.
- (2) If T has exactly one column, return the right column of T . Otherwise, let $T_i := T_2$ be the tableau formed by the first two columns of T .
- (3) If the length of the two columns of T_i is the same, put $T'_i := T_i$. Else, play the SJDT on T_i until both column lengths are swapped, obtaining T'_i .
- (4) If T has more than i columns, redefine $i := i + 1$, and define T_i to be the two-columned tableau formed with the rightmost column of T'_{i-1} and the i -th column of T , and go back to 2. Else, return the right column of the rightmost column of T'_i .

This algorithm is illustrated on the top path of (5.2).

Corollary 5.4. If T is a rectangular tableau, $K_+(T) = r C_k r C_k \cdots r C_k$ (k times).

Let $T = C_1 C_2 \cdots C_k$ be a KN tableau with columns C_1, C_2, \dots, C_k . We note that given a tableau T , to compute which entries appear in the i -th column of $K_-(T)$ we only need to look to the first i columns of T . We need the first column of a skew tableau obtained by applying the SJDT to the columns $C_1 \cdots C_i$ of T , so that the first column has the length of C_i . Let $K_-^1(T)$ be the map that given a tableau returns the last column of $K_-(T)$.

In Example 5.2 we have $K_-(T) = K_-^1(C_1)K_-^1(C_1C_2)K_-^1(C_1C_2C_3)$. In general, $K_-(T) = K_-^1(C_1) \cdots K_-^1(C_1 \cdots C_k)$. Next we present how we compute $K_-^1(T)$ using SJDT:

Algorithm 5.5. Let k be the number of columns of T and $i = k - 1$.

- (1) If T has exactly one column, return the left column of T . Otherwise, let $T_i := T_{k-1}$ be the tableau formed by the last two columns of T .
- (2) If the length of the two columns of T_i is the same, put $T'_i := T_i$. Else, play the SJDT on T_i until both column lengths are swapped, obtaining T'_i .
- (3) If $i \neq 1$, redefine $i := i - 1$, and define T_i as the two-columned tableau formed with the leftmost column of T'_{i+1} and the i -th column of T , and go back to (1). Else, return the left column of the leftmost column of T'_i .

This algorithm is exemplified on the bottom path of Example 5.2.

Corollary 5.6. *If T is a rectangular tableau, $K_-(T) = \ell C_1 \ell C_1 \cdots \ell C_1$ (k times).*

Next, we present a way of computing $K_+^1(T)$ that does not require the SJDT. Willis has done this when T is a SSYT [51]. It is a simplified version of the algorithm presented here.

6. DIRECT WAY: RIGHT AND LEFT

6.1. Right key. Let $T = C_1C_2$ be a straight KN two column tableau and $spl(T) = \ell C_1 r C_1 \ell C_2 r C_2$ a straight semistandard tableau. In particular, $r C_1 \ell C_2$ is a semistandard tableau. The *matching between $r C_1$ and ℓC_2* is defined as follows:

- Let $\beta_1 < \cdots < \beta_{m'}$ be the elements of ℓC_2 . Let i go from m' to 1, match β_i with the biggest, not yet matched, element of $r C_1$ smaller or equal than β_i .

Theorem 6.1 (The direct way algorithm for the right key). *Let T be a straight KN tableau with columns C_1, C_2, \dots, C_k , and consider its split form $spl(T)$. For every right column $r C_2, \dots, r C_k$, add empty cells to the bottom in order to have all columns with the same length as $r C_1$. We will fill all of these empty cells recursively, proceeding from left to right. The extra numbers that are written in the column $r C_2$ are found in the following way:*

- match $r C_1$ and ℓC_2 .
- Let $\alpha_1 < \cdots < \alpha_m$ be the elements of $r C_1$. Let i go from 1 to m . If α_i is not matched with any entry of ℓC_2 , write in the new empty cells of $r C_2$ the smallest element bigger or equal than α_i such that neither it nor its symmetric exist in $r C_2$ or in its new cells. Let C'_2 be the column defined by $r C_2$ together with the filled extra cells, after ordering.

To compute the filling of the extra cells of $r C_3$, we do the same thing, with C'_2 and C_3 . If we do this for all pairs of consecutive columns, we eventually obtain a column C'_k , consisting of $r C_k$ together with extra cells, with the same length as $r C_1$. We claim that $C'_k = K_+^1(T)$.

Example 6.2. Let $T = C_1C_2C_3 = \begin{array}{|c|c|c|} \hline 1 & 3 & \bar{1} \\ \hline 3 & \bar{3} & \\ \hline & & 3 \\ \hline \end{array}$, with split form $spl(T) = \begin{array}{|c|c|c|c|c|c|} \hline 1 & 1 & 2 & 3 & \bar{1} & \bar{1} \\ \hline 2 & 3 & \bar{3} & \bar{2} & & \\ \hline & & 3 & \bar{2} & & \\ \hline \end{array}$. We match $r C_1$

and ℓC_2 , as indicated by the letters a and b : $\begin{array}{|c|c|c|c|c|c|} \hline 1 & 1^a & 2^a & 3 & \bar{1} & \bar{1} \\ \hline 2 & 3^b & \bar{3}^b & \bar{2} & & \\ \hline & & 3 & \bar{2} & & \\ \hline \end{array}$. Hence $\bar{2}$ creates a $\bar{1}$ in $r C_2$, completing

the right column $r C_2$: $\begin{array}{|c|c|c|c|c|c|} \hline 1 & 1 & 2 & 3 & \bar{1}^a & \bar{1} \\ \hline 2 & 3 & \bar{3} & \bar{2} & & \\ \hline 3 & \bar{2} & & \bar{1}^a & & \\ \hline \end{array}$. Now we match C'_2 and ℓC_3 , which is already done, and see

what new cells 3 and $\bar{2}$ we create in rC_3 , obtaining $\begin{array}{|c|c|c|c|c|c|} \hline 1 & 1 & 2 & 3 & \bar{1} & \bar{1} \\ \hline 2 & 3 & \bar{3} & \bar{2} & & 3 \\ \hline \bar{3} & \bar{2} & & \bar{1} & & \bar{2} \\ \hline \end{array}$. Hence $K_+^1(T) = \begin{array}{|c|} \hline 3 \\ \hline \bar{2} \\ \hline \bar{1} \\ \hline \end{array}$ is obtained

from C'_3 after reordering its entries.

6.2. The proof of Theorem 6.1. It is enough to prove that by the end of this algorithm, the entries in C'_k are the entries on the right column of the rightmost column of T'_k from Algorithm 5.3. In fact, it is enough to do this for $k = 2$. For bigger k note that the entries that are "slid" into C_k come from rC_{k-1} , so, to go to the next step on the SJDT algorithm we only need to know the previous right column, which is exactly what we claim to compute this way. The next lemma determines which number is added to rC_2 given that we know α , the entry that is horizontally slid:

Lemma 6.3. *Suppose that $T = C_1C_2$ is a non-rectangular two-column tableau (if the tableau is rectangular then we have nothing to do). Play the SJDT on this tableau which ends up moving one cell from the first column to the second (some entries may change their values). Then,*

- *Immediately before the horizontal slide of the SJDT, the entry α , on the left of the puncture, is an unmatched cell of rC_1 .*
- *Call C'_1 and C'_2 to both columns after the horizontal slide on T . The new entry in rC'_2 , compared to rC_2 , is the smallest element bigger or equal than α such that neither it nor its symmetric exist in rC_2 .*

Example 6.4. Let $T = \begin{array}{|c|c|} \hline 2 & 3 \\ \hline 3 & 4 \\ \hline 5 & \bar{5} \\ \hline \bar{5} \\ \hline \bar{2} \\ \hline \end{array}$. After splitting, and just before the first horizontal slide, we have

$T = \begin{array}{|c|c|c|c|} \hline 1 & 2 & 3 & 3 \\ \hline 3 & 3 & 4 & 4 \\ \hline 4 & 5 & \bar{5} & \bar{5} \\ \hline \bar{5} & \bar{4} & * & * \\ \hline \bar{2} & \bar{1} & & \\ \hline \end{array}$. The new entry in rC_2 is $\bar{2}$, as predicted by the lemma: $\begin{array}{|c|c|c|c|} \hline 1 & 2 & 2 & 3 \\ \hline 3 & 3 & 3 & 4 \\ \hline 4 & 4 & \bar{5} & \bar{5} \\ \hline * & * & \bar{4} & \bar{2} \\ \hline \bar{2} & \bar{1} & & \\ \hline \end{array}$.

Proof. Case 1: α is barred. Then $C'_2 = C_2 \cup \{\alpha\}$. If $\bar{\alpha}$ does not exist neither in C_2 nor in $\Phi(C_2)$, then α will exist in both C'_2 and $\Phi(C'_2)$. If $\bar{\alpha}$ does exist in C_2 , and consequently in $\Phi(C_2)$ (but $\alpha \notin \Phi(C_2)$), then α and $\bar{\alpha}$ will both exist in C'_2 . Hence, in the construction of the barred part of $\Phi(C'_2)$, compared to $\Phi(C_2)$, there will be a new barred number which is the smallest number bigger (or equal, but the equality can not happen) than α such that neither it nor its symmetric exist in the barred part of $\Phi(C_2)$ or the unbarred part of C_2 (i.e., rC_2). If α existed in $\Phi(C_2)$, then $\bar{\alpha}$ existed in $\Phi(C_2)$. That means that whatever number got sent to α in the construction of $\Phi(C_2)$ will be sent to the next available number, meaning that in rC_2 will appear a new number, the smallest number bigger (or equal, but the equality can not happen because α is already there) than α such that neither it nor its symmetric exist in rC_2 .

Case 2: α is unbarred. Then $C'_2 = \Phi^{-1}(\Phi(C_2) \cup \{\alpha\})$. If $\bar{\alpha}$ does not exist in C_2 nor in $\Phi(C_2)$, then α will exist in both C'_2 and $\Phi(C'_2)$. If $\bar{\alpha}$ existed in $\Phi(C_2)$, and consequently in C_2 , then both α and $\bar{\alpha}$ will exist in $\Phi(C'_2)$, hence, if we start in the coadmissible column, in the construction of the unbarred part of C'_2 , compared to C_2 , there will be a new unbarred number which is the smallest number bigger than α such that neither it nor its symmetric exist in rC_2 . Finally, if α existed in C_2 , then $\bar{\alpha}$ also existed in C_2 . That means that whatever number got sent to α in the construction of C_2 , from $\Phi(C_2)$, will be sent to the next available number, meaning that in rC_2 will appear a new number, the smallest number bigger than α such that neither it nor its symmetric exist in rC_2 . \square

Proof of Theorem 6.1: Each SJDT in T , a two-column skew tableau, moves a cell from the first to the second column. We will prove that if we apply the direct way algorithm after each SJDT, the output C'_2 does not change. The cells on ℓC_2 without cells to its left do not get to be matched. When we slide horizontally, the columns rC_1 and ℓC_2 may change more than the adding/removal of α , the horizontally slid entry. Since the horizontal slides happen from top to bottom, we only need to see what changes happen to bigger entries than the one slid. All entries above α are matched to the entry in the same row in ℓC_2 .

If α is barred then, the remaining barred entries of rC_1 and ℓC_2 remain unchanged, and since all entries above α , including the unbarred ones, are matched to the entry directly on their right, there is no noteworthy change and everything runs as expected.

If α is unbarred then, the remaining unbarred entries of rC_1 and ℓC_2 remain unchanged. In the barred part of rC_1 either nothing happens, or there is an entry bigger than $\bar{\alpha}$, \bar{x} , that gets replaced by $\bar{\alpha}$. Note that \bar{x} must be such that for every number between \bar{x} and $\bar{\alpha}$, either it or its symmetric existed in rC_1 . In the barred part of ℓC_2 , if $\bar{\alpha} \in \ell C_2$, then $\bar{\alpha}$ gets replaced by \bar{y} , smaller than $\bar{\alpha}$, such that for every number between \bar{y} and $\bar{\alpha}$, either it or its symmetric existed in ℓC_2 , and both y and \bar{y} do not exist in ℓC_2 .

Let's look to ℓC_2 . Let $\alpha < p_1 < p_2 < \dots < p_m = y$ be the numbers between α and y that does not exist in ℓC_2 , right before the horizontal slide. Then, their symmetric exist in ℓC_2 . For all numbers in rC_2 between α and y , there exists, in the same row in rC_1 , a number between α and y . Let $\alpha < p'_1 < p'_2 < \dots < p'_m = y$ be the missing numbers between α and y in rC_1 , then $p_i \leq p'_i$. Note that $\bar{p}_1 > \bar{p}_2 > \dots > \bar{p}_m = \bar{y}$ exist in ℓC_2 after the horizontal slide and that the biggest numbers between $\bar{\alpha}$ and \bar{y} (not including $\bar{\alpha}$) that can exist in rC_1 are $\bar{p}'_1 > \bar{p}'_2 > \dots > \bar{p}'_m$, and since $\bar{p}_i \geq \bar{p}'_i$, the matching holds for this interval after swapping $\bar{\alpha}$ by \bar{y} in ℓC_2 .

Now let's look to rC_1 . Before the slide, call \bar{x}' to the biggest unmatched number of rC_1 smaller or equal than \bar{x} . If there is no such \bar{x}' , then everything in rC_1 between $\bar{\alpha}$ and \bar{x} is matched, hence swapping \bar{x} by $\bar{\alpha}$ will keep all of them matched, meaning that the algorithm works in this scenario. Let $x' < q_1 < q_2 < \dots < q_m < \alpha$ be the numbers between x' and α that does not exist in rC_1 , right before the horizontal slide. Then, their symmetric exist in rC_1 . For all numbers in rC_1 between x' and α , there exists, in the same row in ℓC_2 , a number between x' and α , because α is unmatched. Let $x' < q'_1 < q'_2 < \dots < q'_m < \alpha$ be the missing numbers between x' and α in ℓC_2 , then $q_i \geq q'_i$. Note that $\bar{q}_1 > \bar{q}_2 > \dots > \bar{q}_m > \bar{\alpha}$ exist in rC_1 after the horizontal slide and the numbers between x' and $\bar{\alpha}$ that can exist in ℓC_2 are $\bar{q}'_1 > \bar{q}'_2 > \dots > \bar{q}'_m$, and since $\bar{q}_i \leq \bar{q}'_i$, these numbers are matching a number bigger or equal then q_i in rC_1 , meaning that α is unmatched in rC_1 . Ignoring signs, the numbers that appear in either rC_1 or ℓC_2 are the same. So before playing the SJDT, applying the direct way algorithm we have that the unmatched numbers in rC_1 are sent to the not used numbers of $\bar{q}'_1 > \bar{q}'_2 > \dots > \bar{q}'_m$ in ℓC_2 (this is a bijection), and \bar{x}' is sent to the smallest available number, bigger or equal than \bar{x}' . Now consider rC_1 and ℓC_2 after the slide. In rC_1 we replace x' by $\bar{\alpha}$ and remove α and in ℓC_2 there is α or $\bar{\alpha}$. In the direct algorithm, all unmatched numbers of $\bar{q}_1 > \bar{q}_2 > \dots > \bar{q}_m > \bar{\alpha}$ are sent to the not used numbers of $\bar{q}'_1 > \bar{q}'_2 > \dots > \bar{q}'_m$ in ℓC_2 , but now we have more numbers in the first set than in the second, meaning that $\bar{\alpha}$ will bump the image of the least unmatched number, which will bump the image of the second least unmatched number, and so on, meaning that the image of biggest unmatched will be out of this set. This image will be the smallest number available, which was the image of x' before the horizontal slide.

Hence, the outcome of the direct way does not change due to the changes to the columns when we play the SJDT, meaning that the outcome is what we intend. \square

6.3. Left key - a direct way.

Theorem 6.5. *Let T be a KN tableau with columns C_1, C_2, \dots, C_k , and consider its split form $spl(T)$.*

We will now delete entries from the left columns, proceeding from right to left, in such a way that in the end every left column has as many entries as C_k . The entries deleted from ℓC_{k-1} are found in the following way:

We start by creating a matching between rC_{k-1} and ℓC_k . Let $\beta_1 < \dots < \beta_m$ be the unmatched elements of rC_{k-1} . For i between 1 and m , let α_i be the entry on ℓC_{k-1} next to β_i . Let i go from 1 to m . Starting at α_i and going up, delete the first entry of ℓC_{k-1} bigger than the entry directly Northeast of it. If there is no entry in this conditions, delete the top entry of ℓC_{k-1} . Also delete β_i from rC_{k-1} . By the end of this procedure we obtain $\ell C'_{k-1}$ with the same number of cells as C_k .

To continue the algorithm, we do the same thing with C_{k-2} and $\ell C'_{k-1}$. If we do this for all pairs of consecutive columns, we eventually obtain a column $\ell C'_1$, consisting of ℓC_1 with some entries deleted, with the same length as C_k . We claim that $\ell C'_1 = K_-^1(T)$.

Example 6.6. Consider $T = \begin{array}{|c|c|c|} \hline 2 & 3 & \bar{3} \\ \hline 3 & \bar{3} & \\ \hline \bar{3} & & \\ \hline \end{array}$ whose split form is $spl(T) = \begin{array}{|c|c|c|c|c|c|} \hline 1 & 2 & 2 & 3 & \bar{3} & \bar{3} \\ \hline 2 & 3 & \bar{3} & \bar{2} & & \\ \hline \bar{3} & \bar{1} & & & & \\ \hline \end{array}$. We match rC_2

and ℓC_3 , obtaining: $\begin{array}{|c|c|c|c|c|c|} \hline 1 & 2 & 2 & 3^a & \bar{3}^a & \bar{3} \\ \hline 2 & 3 & \bar{3} & \bar{2} & & \\ \hline \bar{3} & \bar{1} & & & & \\ \hline \end{array}$. Hence $\bar{2}$ is unmatched in rC_2 . So it will get deleted, alongside

the $\bar{3}$ in ℓC_2 . Thus we have $\begin{array}{|c|c|c|c|c|c|} \hline 1 & 2^a & 2^a & 3 & \bar{3} & \bar{3} \\ \hline 2 & 3 & \bar{3} & \bar{2} & & \\ \hline \bar{3} & \bar{1} & & & & \\ \hline \end{array}$ (the deleted entries are greyed out).

Now we have to create the match between $\ell C'_2$ and rC_1 , which is already done. The entries 3 and $\bar{1}$ are unmatched in rC_1 , hence they will be removed alongside the entries 1 and $\bar{3}$ in ℓC_1 , obtaining

$\begin{array}{|c|c|c|c|c|c|} \hline 1 & 2 & 2 & 3 & \bar{3} & \bar{3} \\ \hline 2 & 3 & \bar{3} & \bar{2} & & \\ \hline \bar{3} & \bar{1} & & & & \\ \hline \end{array}$. Hence $K_-^1(T) = \begin{array}{|c|} \hline 2 \\ \hline \end{array}$.

6.4. Proof of Theorem 6.5. It is enough to prove that by the end of this algorithm, the entries in $\ell C'_j$ are the entries on the left column of the leftmost column of T'_j from Algorithm 5.5. Just like in the right key case, it is enough to do this for $j = k - 1$. For smaller j note that we only need to know what remains in the left column $\ell C'_j$, which is exactly what we claim to compute this way.

So only need to prove this when T is a two-column tableaux.

Lemma 6.7. *Suppose that T is a non-rectangular two-column tableau (if the tableau is rectangular then we have nothing to do). Play the SJDT on this tableau, which ends up moving one cell from the first column to the second (some entries may change its value). Immediately before the horizontal slide of the SJDT, the entry β , on the left of the puncture, is an unmatched cell of rC_1 . Call C'_1 and C'_2 to both columns after the slide.*

Then $\ell C'_1$ will lose an entry, compared to ℓC_1 , which is the biggest entry of ℓC_1 , in a row not under the row that contains β , bigger than the entry directly Northeast of it.

Example 6.8. Consider the tableau $T = \begin{array}{|c|c|} \hline 2 & 3 \\ \hline 4 & 4 \\ \hline 5 & \bar{2} \\ \hline 5 \\ \hline 2 \\ \hline \end{array}$. After split, and just before the horizontal slide, we

have $T = \begin{array}{|c|c|c|c|} \hline 1 & 2 & 3 & 3 \\ \hline 3 & 4 & 4 & 4 \\ \hline 4 & 5 & * & * \\ \hline \bar{5} & \bar{3} & \bar{2} & \bar{2} \\ \hline 2 & \bar{1} & & \\ \hline \end{array}$. So 5 slides from rC_1 to ℓC_2 , obtaining the tableau $\begin{array}{|c|c|} \hline 2 & 3 \\ \hline 4 & 4 \\ \hline * & \bar{5} \\ \hline \bar{5} & \bar{2} \\ \hline 2 \\ \hline \end{array}$, whose split is

$$\begin{array}{|c|c|c|c|} \hline 1 & 2 & 3 & 3 \\ \hline 4 & 4 & 4 & 4 \\ \hline * & * & 5 & 5 \\ \hline \bar{5} & \bar{5} & \bar{2} & \bar{2} \\ \hline 2 & \bar{1} & & \\ \hline \end{array}$$

. The entry removed from ℓC_1 is 3, as predicted by the lemma.

Proof. If β is unbarred then look at all numbers $\beta \leq i \leq n$, and count, in C_1 , count how many of them exist together with its symmetric and it is not matched to a number with bigger than β in the coadmissible column. Let k be that count. Now let i go from $\beta - 1$ to 1. If i and \bar{i} exist in C_1 then $k := k + 1$, and if neither exist then $k := k - 1$. Since C_1 is admissible, eventually $k = 0$ and this is the i removed from ℓC_1 . So, the columns ℓC_1 and rC_1 have same number of entries with absolute value bigger or equal than i , hence the entry i of ℓC_1 is bigger than the entry directly Northeast of it.

If β is barred then look at all numbers $\beta \leq i \leq \bar{1}$, and count, in C_1 , count how many of them exist together with its symmetric and it is not matched to a number bigger than β in the coadmissible column. Let k be that count. Now let i go from $\beta - 1$ to \bar{n} . If i and \bar{i} exist in C_1 then $k := k + 1$, and if neither exist then $k := k - 1$. Since $\Phi(C_1)$ is coadmissible, eventually $k = 0$ and this is the i removed from ℓC_1 . The columns ℓC_1 and rC_1 have same number of entries with absolute value smaller or equal than \bar{i} , hence the entry i of ℓC_1 is bigger than the entry directly Northeast of it (remember that i is negative). \square

Proof of Theorem 6.5: Hence we have determined which entry is removed from ℓC_1 given that we know β , the entry of the cell that is horizontally slid. The SJDT on T may change the entries or the matching in rC_1 . We need to prove that, even with these eventual changes, the entries removed from ℓC_1 are the ones that we calculated in the beginning, before doing any SJDT slide.

If β is barred, since we run the unmatched entries of rC_1 from smallest to biggest, when removing β from rC_1 the unbarred part of rC_1 remains the same, hence, the remaining entries and matched entries do not change, hence the outcome will be the one predicted.

If β is unbarred then the remaining unbarred entries of rC_1 remain unchanged. In the barred part of rC_1 either nothing happens, or there is an entry bigger than $\bar{\beta}$, \bar{x} , that gets replaced by $\bar{\beta}$. Note that \bar{x} must be such that for every number between \bar{x} and $\bar{\beta}$, either it or its symmetric existed in rC_1 . This can only happen if k , from the proof of Lemma 6.7 starts being bigger than 0.

Since for all numbers between \bar{x} and $\bar{\beta}$ either it or its symmetric exist in rC_1 , all unmatched entries here will remove from ℓC_1 an entry smaller or equal than \bar{x} . In fact, the way of constructing \bar{x} and i , from the proof of Lemma 6.7, is effectively the same. Since, after the slide of β , we may have different matches in the numbers between \bar{x} and $\bar{\beta}$, and the number of unmatched entries remains the same after the slide. Since all unmatched entries in here will remove something smaller or equal than $\bar{\beta}$ from ℓC_1 , the outcome of the algorithm is the same as if we apply it to ℓC_1 , rC_1 before or after the horizontal slide. Hence we do not need to do any SJDT in order to know the entries of ℓC_1 after the SJDT. \square

6.5. SJDT and direct keys example. In this section we illustrate the computation of the right and left keys of a KN tableau via SJDT and using the *direct way*.

Let $n = 5$ and let be $T =$

2	3	3	4
4	4	4	4
5	3	2	
4			
3			

 the KN tableau with split form

$$spl(T) = \begin{array}{cccccccc} 1 & 2 & 2 & 3 & 3 & 3 & 3 & 4 \\ 2 & 4 & 4 & 4 & 4 & 4 & 4 & 3 \\ 5 & 5 & 3 & 2 & 2 & 2 & & \\ 4 & 3 & & & & & & \\ 3 & 1 & & & & & & \end{array} .$$

In order to find the right (resp. left) key of T , we play the SJDT to swap heights of consecutive columns, and find skew tableaux, Knuth related to T , such that for every column height there is a skew tableau whose last column (resp. first) has that height.

<table border="1"><tr><td>2</td><td>3</td><td>3</td><td>4</td></tr><tr><td>4</td><td>4</td><td>4</td><td>4</td></tr><tr><td>5</td><td>3</td><td>2</td><td></td></tr><tr><td>4</td><td></td><td></td><td></td></tr><tr><td>3</td><td></td><td></td><td></td></tr></table>	2	3	3	4	4	4	4	4	5	3	2		4				3				<table border="1"><tr><td>3</td><td>3</td><td>4</td></tr><tr><td>5</td><td>4</td><td>4</td></tr><tr><td>5</td><td>4</td><td></td></tr><tr><td>3</td><td>3</td><td></td></tr></table>	3	3	4	5	4	4	5	4		3	3		<table border="1"><tr><td></td><td></td><td>4</td></tr><tr><td>3</td><td>3</td><td>4</td></tr><tr><td>5</td><td>4</td><td>2</td></tr><tr><td>2</td><td>5</td><td></td></tr><tr><td>5</td><td>4</td><td></td></tr><tr><td>3</td><td>3</td><td></td></tr></table>			4	3	3	4	5	4	2	2	5		5	4		3	3		<table border="1"><tr><td>3</td><td>4</td></tr><tr><td>5</td><td>4</td></tr><tr><td>5</td><td>2</td></tr><tr><td>2</td><td>2</td><td>4</td></tr><tr><td>5</td><td>4</td><td>2</td></tr><tr><td>3</td><td></td><td></td></tr></table>	3	4	5	4	5	2	2	2	4	5	4	2	3			<table border="1"><tr><td></td><td>3</td><td>4</td></tr><tr><td></td><td>5</td><td>4</td></tr><tr><td></td><td>5</td><td>2</td></tr><tr><td>2</td><td>2</td><td>5</td><td>2</td></tr><tr><td>2</td><td>4</td><td>4</td><td></td></tr><tr><td>5</td><td>3</td><td>2</td><td></td></tr></table>		3	4		5	4		5	2	2	2	5	2	2	4	4		5	3	2		<table border="1"><tr><td></td><td></td><td>4</td></tr><tr><td></td><td>2</td><td>3</td><td>5</td></tr><tr><td>2</td><td>4</td><td>4</td><td>4</td></tr><tr><td>5</td><td>3</td><td>2</td><td>2</td></tr></table>			4		2	3	5	2	4	4	4	5	3	2	2
2	3	3	4																																																																																																							
4	4	4	4																																																																																																							
5	3	2																																																																																																								
4																																																																																																										
3																																																																																																										
3	3	4																																																																																																								
5	4	4																																																																																																								
5	4																																																																																																									
3	3																																																																																																									
		4																																																																																																								
3	3	4																																																																																																								
5	4	2																																																																																																								
2	5																																																																																																									
5	4																																																																																																									
3	3																																																																																																									
3	4																																																																																																									
5	4																																																																																																									
5	2																																																																																																									
2	2	4																																																																																																								
5	4	2																																																																																																								
3																																																																																																										
	3	4																																																																																																								
	5	4																																																																																																								
	5	2																																																																																																								
2	2	5	2																																																																																																							
2	4	4																																																																																																								
5	3	2																																																																																																								
		4																																																																																																								
	2	3	5																																																																																																							
2	4	4	4																																																																																																							
5	3	2	2																																																																																																							

Each tableau is obtained from the previous after playing SJDT in two consecutive columns, swapping their heights.

If we compute the right (resp. left) columns of all last (resp. first) columns of these tableaux, we find the columns of the right (resp. left) key associated to T :

$$K_+(T) = \begin{array}{cccc} 4 & 4 & 4 & 4 \\ 5 & 3 & 3 & 3 \\ 3 & 2 & 2 & \\ 2 & & & \\ 1 & & & \end{array} \quad \text{and} \quad K_-(T) = \begin{array}{cccc} 1 & 2 & 2 & 2 \\ 2 & 5 & 5 & 5 \\ 5 & 3 & 3 & \\ 4 & & & \\ 3 & & & \end{array} .$$

Note that we have 9 horizontal slides in our sequence of tableaux, and for each horizontal slide we have to apply the map Φ , or its inverse twice. This means that we are effectively computing the split form of 9 skew tableaux, even though we only need 3 tableaux (the first, the third and the last one) to have all column heights in each end of the tableau.

Now we compute both keys using the direct way. In here we only need to compute one split form, and make some calculations on it, and on subtableaux of the split form.

To compute the *right key*, via *direct way*, we need to compute the columns $K_+^1 \left(\begin{array}{cccc} 2 & 3 & 3 & 4 \\ 4 & 4 & 4 & 4 \\ 5 & 3 & 2 & \\ 4 & & & \\ 3 & & & \end{array} \right),$

$$K_+^1 \left(\begin{array}{ccc} 3 & 3 & 4 \\ 4 & 4 & 4 \\ 3 & 2 & \end{array} \right) = K_+^1 \left(\begin{array}{cc} 3 & 4 \\ 4 & 4 \\ 2 & \end{array} \right) \text{ and } K_+^1 \left(\begin{array}{c} 4 \\ 4 \end{array} \right).$$

We start by splitting and matching, and every \mapsto marks when new entries, written in blue, are added to a right column, and we do these until there are no columns left.

$$\begin{array}{|c|c|c|c|} \hline 2 & 3 & 3 & 4 \\ \hline 4 & 4 & \overline{4} & \overline{4} \\ \hline \overline{5} & \overline{3} & \overline{2} & \\ \hline \overline{4} & & & \\ \hline \overline{3} & & & \\ \hline \end{array} \xrightarrow{\text{split}} \begin{array}{|c|c|c|c|c|c|c|c|} \hline 1 & 2^a & 2^a & 3 & 3 & 3 & 3 & 4 \\ \hline 2 & 4 & \overline{4}^b & \overline{4} & \overline{4} & \overline{4} & \overline{4} & \overline{3} \\ \hline \overline{5} & \overline{5}^b & \overline{3}^c & \overline{2} & \overline{2} & \overline{2} & & \\ \hline \overline{4} & \overline{3}^c & & & & & & \\ \hline \overline{3} & \overline{1} & & & & & & \\ \hline \end{array} \mapsto \begin{array}{|c|c|c|c|c|c|c|c|} \hline 1 & 2 & 2 & 3^a & 3^a & 3 & 3 & 4 \\ \hline 2 & 4 & \overline{4} & \overline{5} & \overline{4}^b & \overline{4} & \overline{4} & \overline{3} \\ \hline \overline{5} & \overline{5} & \overline{3} & \overline{4}^b & \overline{2}^c & \overline{2} & & \\ \hline \overline{4} & \overline{3} & & \overline{2}^c & & & & \\ \hline \overline{3} & \overline{1} & & \overline{1} & & & & \\ \hline \end{array} \mapsto \begin{array}{|c|c|c|c|c|c|c|c|} \hline 1 & 2 & 2 & 3 & 3 & 3 & 3 & 4 \\ \hline 2 & 4 & \overline{4} & \overline{5} & \overline{4} & \overline{5} & \overline{4} & \overline{5} \\ \hline \overline{5} & \overline{5} & \overline{3} & \overline{4} & \overline{2} & \overline{4} & & \overline{3} \\ \hline \overline{4} & \overline{3} & & \overline{2} & & \overline{2} & & \overline{2} \\ \hline \overline{3} & \overline{1} & & \overline{1} & & \overline{1} & & \overline{1} \\ \hline \end{array}, \quad K_+^1(T) = \begin{array}{|c|} \hline \overline{4} \\ \hline \overline{5} \\ \hline \overline{3} \\ \hline \overline{2} \\ \hline \overline{1} \\ \hline \end{array};$$

$$\begin{array}{|c|c|} \hline 3 & 4 \\ \hline \overline{4} & \overline{4} \\ \hline \overline{2} & \\ \hline \end{array} \xrightarrow{\text{split}} \begin{array}{|c|c|c|c|} \hline 3 & 3^a & 3^a & 4 \\ \hline \overline{4} & \overline{4}^b & \overline{4}^b & \overline{3} \\ \hline \overline{2} & \overline{2} & & \\ \hline \end{array} \mapsto \begin{array}{|c|c|c|c|} \hline 3 & 3 & 3 & 4 \\ \hline \overline{4} & \overline{4} & \overline{4} & \overline{3} \\ \hline \overline{2} & \overline{2} & & \overline{2} \\ \hline \end{array}, \quad K_+^1\left(\begin{array}{|c|c|c|} \hline 3 & 3 & 4 \\ \hline \overline{4} & \overline{4} & \overline{4} \\ \hline \overline{3} & \overline{2} & \\ \hline \end{array}\right) = K_+^1\left(\begin{array}{|c|c|} \hline 3 & 4 \\ \hline \overline{4} & \overline{4} \\ \hline \overline{2} & \\ \hline \end{array}\right) = \begin{array}{|c|} \hline \overline{4} \\ \hline \overline{3} \\ \hline \overline{2} \\ \hline \end{array};$$

$$\begin{array}{|c|} \hline \overline{4} \\ \hline \overline{4} \\ \hline \end{array} \xrightarrow{\text{split}} \begin{array}{|c|c|} \hline \overline{3} & \overline{4} \\ \hline \overline{4} & \overline{3} \\ \hline \end{array}, \quad K_+^1\left(\begin{array}{|c|} \hline \overline{4} \\ \hline \end{array}\right) = \begin{array}{|c|} \hline \overline{4} \\ \hline \overline{3} \\ \hline \end{array}.$$

To compute the *left key*, via *direct way*, we need to compute the columns $K_-^1\left(\begin{array}{|c|c|c|c|} \hline 2 & 3 & 3 & 4 \\ \hline \overline{4} & \overline{4} & \overline{4} & \overline{4} \\ \hline \overline{5} & \overline{3} & \overline{2} & \\ \hline \overline{4} & & & \\ \hline \overline{3} & & & \\ \hline \end{array}\right)$,

$$K_-^1\left(\begin{array}{|c|c|} \hline 2 & 3 \\ \hline \overline{4} & \overline{4} \\ \hline \overline{5} & \overline{3} \\ \hline \overline{4} & \\ \hline \overline{3} & \\ \hline \end{array}\right) = K_-^1\left(\begin{array}{|c|c|c|} \hline 2 & 3 & 3 \\ \hline \overline{4} & \overline{4} & \overline{4} \\ \hline \overline{5} & \overline{3} & \overline{2} \\ \hline \overline{4} & & \\ \hline \overline{3} & & \\ \hline \end{array}\right) \text{ and } K_-^1\left(\begin{array}{|c|} \hline 2 \\ \hline \overline{4} \\ \hline \overline{5} \\ \hline \overline{4} \\ \hline \overline{3} \\ \hline \end{array}\right). \text{ We start by splitting and matching, and every}$$

\mapsto marks when entries are removed from a left column, and we do these until there are no columns left. Recall that this algorithm goes from right to left.

$$\begin{array}{|c|c|c|c|} \hline 2 & 3 & 3 & 4 \\ \hline 4 & \overline{4} & \overline{4} & \overline{4} \\ \hline \overline{5} & \overline{3} & \overline{2} & \\ \hline \overline{4} & & & \\ \hline \overline{3} & & & \\ \hline \end{array} \xrightarrow{\text{split}} \begin{array}{|c|c|c|c|c|c|c|c|} \hline 1 & 2 & 2 & 3 & 3 & 3^a & 3^a & 4 \\ \hline 2 & 4 & \overline{4} & \overline{4} & \overline{4} & \overline{4}^b & \overline{4}^b & \overline{3} \\ \hline \overline{5} & \overline{5} & \overline{3} & \overline{2} & \overline{2} & \overline{2} & & \\ \hline \overline{4} & \overline{3} & & & & & & \\ \hline \overline{3} & \overline{1} & & & & & & \\ \hline \end{array} \mapsto \begin{array}{|c|c|c|c|c|c|c|c|} \hline 1 & 2 & 2 & 3^a & 3^a & 3 & 3 & 4 \\ \hline 2 & 4 & \overline{4} & \overline{4}^b & \overline{4}^b & \overline{4} & \overline{4} & \overline{3} \\ \hline \overline{5} & \overline{5} & \overline{3} & \overline{2} & & & & \\ \hline \overline{4} & \overline{3} & & & & & & \\ \hline \overline{3} & \overline{1} & & & & & & \\ \hline \end{array} \mapsto \begin{array}{|c|c|c|c|c|c|c|c|} \hline & 2 & 2 & 3 & 3 & 3 & 3 & 4 \\ \hline 2 & \overline{4} & \overline{4} & \overline{4} & \overline{4} & \overline{4} & \overline{4} & \overline{3} \\ \hline \overline{5} & \overline{5} & \overline{2} & \overline{2} & & & & \\ \hline & & & & & & & \\ \hline & & & & & & & \\ \hline \end{array}, \quad K_-^1(T) = \begin{array}{|c|} \hline \overline{2} \\ \hline \overline{5} \\ \hline \end{array}.$$

In the final step, we are removing $\overline{3}$ from ℓC_1 , because the entry directly Northeast of it is $\overline{5}$, because the $\overline{3}$ of rC_1 has already been slid out.

$$\begin{array}{|c|c|} \hline 2 & 3 \\ \hline 4 & \overline{4} \\ \hline \overline{5} & \overline{3} \\ \hline \overline{4} & \\ \hline \overline{3} & \\ \hline \end{array} \xrightarrow{\text{split}} \begin{array}{|c|c|c|c|} \hline 1 & 2^a & 2^a & 3 \\ \hline 2 & 4 & \overline{4}^b & \overline{4} \\ \hline \overline{5} & \overline{5}^b & \overline{3}^c & \overline{2} \\ \hline \overline{4} & \overline{3}^c & & \\ \hline \overline{3} & \overline{1} & & \\ \hline \end{array} \mapsto \begin{array}{|c|c|c|c|} \hline & 2 & 2 & 3 \\ \hline 2 & & \overline{4} & \overline{4} \\ \hline \overline{5} & \overline{5} & \overline{3} & \overline{2} \\ \hline & & \overline{3} & \\ \hline \overline{3} & & & \\ \hline \end{array}, \quad K_-^1\left(\begin{array}{|c|c|} \hline 2 & 3 \\ \hline \overline{4} & \overline{4} \\ \hline \overline{5} & \overline{3} \\ \hline \overline{4} & \\ \hline \overline{3} & \\ \hline \end{array}\right) = K_-^1\left(\begin{array}{|c|c|c|} \hline 2 & 3 & 3 \\ \hline \overline{4} & \overline{4} & \overline{4} \\ \hline \overline{5} & \overline{3} & \overline{2} \\ \hline \overline{4} & & \\ \hline \overline{3} & & \\ \hline \end{array}\right) = \begin{array}{|c|} \hline \overline{2} \\ \hline \overline{5} \\ \hline \overline{3} \\ \hline \end{array}.$$

$$\begin{array}{|c|} \hline 2 \\ \hline 4 \\ \hline \bar{5} \\ \hline \bar{4} \\ \hline \bar{3} \\ \hline \end{array} \xrightarrow{\text{split}} \begin{array}{|c|c|} \hline 1 & 2 \\ \hline 2 & 4 \\ \hline \bar{5} & \bar{5} \\ \hline \bar{4} & \bar{3} \\ \hline \bar{3} & \bar{1} \\ \hline \end{array}, \quad K_-^1 \left(\begin{array}{|c|} \hline 2 \\ \hline 4 \\ \hline \bar{5} \\ \hline \bar{4} \\ \hline \bar{3} \\ \hline \end{array} \right) = \begin{array}{|c|} \hline 1 \\ \hline 2 \\ \hline \bar{5} \\ \hline \bar{4} \\ \hline \bar{3} \\ \hline \end{array}.$$

7. VIRTUAL SYMPLECTIC KEYS

In this section we build on [4] and refer to it and [5] for unexplained notation. The Dynkin diagram of an irreducible root system is a graph whose nodes are in bijection with the simple roots and simultaneously with the generators of the corresponding Weyl group W as a Coxeter group. If $\Delta = \{\alpha_i : i \in I\}$ is the set of simple roots of the given root system, the node $i \in I$ in the Dynkin diagram corresponds to $\alpha_i \in \Delta$ and to the simple reflection $s_i \in W$. When folding the Dynkin diagram A_{2n-1} through the node n one obtains the Dynkin diagram C_n , in particular, the hyperoctahedral group B_n embedded as a subgroup of $\mathfrak{S}_{2n} = \langle s_i^A : 1 \leq i < 2n \rangle$. That is, $B_n \simeq B_n^A := \langle \tilde{s}_i := s_i^A s_{2n-i}^A, \tilde{s}_n := s_n^A, 1 \leq i < n \rangle$ as a subgroup of \mathfrak{S}_{2n} . (See also, [6].) More precisely, our construction is based on the Dynkin diagram folding (or quotient) of A_{2n-1}

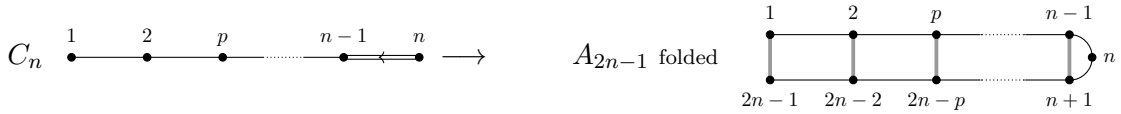

where the nodes of the C_n Dynkin diagram are mapped into the node-pairs of the A_{2n-1} Dynkin diagram as follows: $i \mapsto \{i, 2n-i\}$, $1 \leq i < n$ and $n \mapsto n$. For more details, we refer to [12].

7.1. Baker embedding. Let $\Lambda_1, \dots, \Lambda_n$ be the C_n fundamental weights, and $\Lambda_1^A, \dots, \Lambda_n^A, \dots, \Lambda_{2n-1}^A$ the A_{2n-1} fundamental weights. We also write α_i^A , $1 \leq i \leq 2n-1$, for the A_{2n-1} simple roots. For $\lambda = \Lambda_{m_1} + \dots + \Lambda_{m_k} \in \mathbb{Z}^n$, with $1 \leq m_1 \leq \dots \leq m_k \leq n$, let

$$(30) \quad \lambda^A = \Lambda_{2n-m_1}^A + \Lambda_{m_1}^A + \dots + \Lambda_{2n-m_k}^A + \Lambda_{m_k}^A,$$

be a \mathbb{Z}^{2n} partition with at most $2n-1$ parts, and $\text{SSYT}(\lambda^A, 2n)$ the A_{2n-1} crystal of semistandard tableaux of shape λ^A in the alphabet $[2n]$. We consider inside the A_{2n-1} crystal $\text{SSYT}(\lambda^A, 2n)$ the crystal generated by acting with lowering operators $f_i^E := f_i^A f_{2n-i}^A = f_{2n-i}^A f_i^A$, $1 \leq i < n$, and $f_n^E = (f_n^A)^2$ on the highest weight element $K(\lambda^A)$ of $\text{SSYT}(\lambda^A, 2n)$, where f_i^A denote the A_{2n-1} crystal operators acting on $\text{SSYT}(\lambda^A, 2n)$. This is an embedding of the crystal $\text{KN}(\lambda, n)$ into the crystal $\text{SSYT}(\lambda^A, 2n)$, called Baker embedding [5], $E : \text{KN}(\lambda, n) \hookrightarrow \text{SSYT}(\lambda^A, 2n)$,

$$(31) \quad \begin{aligned} \text{KN}(\lambda, n) &= \{f_{i_1}^{k_1} \dots f_{i_\ell}^{k_\ell}(K(\lambda)) \mid i_1, \dots, i_\ell \in [n], (k_1, \dots, k_\ell) \in \mathbb{Z}_{\geq 0}^\ell, \ell \geq 0\} \setminus \{0\}, \text{ and} \\ E(\text{KN}(\lambda, n)) &= \\ &= \{f_{i_1}^{A k_1} f_{2n-i_1}^{A k_1} \dots f_{i_\ell}^{A k_\ell} f_{2n-i_\ell}^{A k_\ell}(K(\lambda^A)) \mid i_1, \dots, i_\ell \in [n], (k_1, \dots, k_\ell) \in \mathbb{Z}_{\geq 0}^\ell, \ell \geq 0\} \setminus \{0\}. \end{aligned}$$

The *virtual crystal* $E(\text{KN}(\lambda, n))$ models the crystal $\text{K}(\lambda, n)$ inside the A_{2n-1} crystal $\text{SSYT}(\lambda^A, 2n)$.

It is well known that given two semistandard tableaux R and S the column Schensted insertion [17] $[R \leftarrow S] := [R \leftarrow a_1 \leftarrow a_2 \leftarrow \dots \leftarrow a_t]$ with $w(S) = a_1 a_2 \dots a_s$ the Chinese/Japanese reading of S , defines a crystal isomorphism between the crystal connected component containing $R \otimes S$ and respectively the crystal containing $[R \leftarrow S]$. Thus we identify $R \otimes S = [R \leftarrow S] = [\emptyset \leftarrow R \leftarrow S]$ [28]. In particular $K(\lambda) \otimes K(\mu) = K(\lambda + \mu)$ the highest weight element of $\mathfrak{B}(\lambda + \mu) \subseteq \mathfrak{B}(\lambda) \otimes \mathfrak{B}(\mu)$ for $\lambda, \mu \in \mathcal{P}_{2n}$.

Let $\psi : \text{KN}(\Lambda_i, n) \hookrightarrow \text{SSYT}(\Lambda_{2n-i}^A + \Lambda_i^A, 2n) \subseteq \mathfrak{B}(\Lambda_i^A, 2n) \otimes \mathfrak{B}(\Lambda_{2n-i}^A, 2n)$, $1 \leq i \leq n$, be the crystal embedding explicitly defined in [5, Proposition 2.2]. In particular, $\psi(K(\Lambda_i)) = K(\Lambda_{2n-i}^A + \Lambda_i^A)$,

$1 \leq i \leq n$. The embedding of $\text{KN}(\Lambda_i, n)$ in $\text{SSYT}(\Lambda_{2n-i}^A + \Lambda_i^A, 2n)$ is generated in $\text{SSYT}(\lambda^A, 2n)$ by acting with lowering operators

$$(32) \quad f_i^E := \begin{cases} f_i^A f_{2n-i}^A = f_{2n-i}^A f_i^A, & 1 \leq i < n, \\ (f_n^A)^2, & i = n. \end{cases}$$

on the highest weight element $K(\Lambda_{2n-i}^A + \Lambda_i^A)$ of $\text{SSYT}(\Lambda_{2n-i}^A + \Lambda_i^A, 2n)$. That is, $\psi(\text{KN}(\Lambda_i, n))$ is realized in the crystal connected component of $\mathfrak{B}(\Lambda_i^A, 2n) \otimes \mathfrak{B}(\Lambda_{2n-i}^A, 2n)$ with highest weight element $K(\Lambda_{2n-i}^A + \Lambda_i^A)$ by acting successively by lowering operators f_i^E on $K(\Lambda_{2n-i}^A + \Lambda_i^A)$.

For $\lambda \in \mathcal{P}_n$ and λ^A in (30), the Baker virtualization [5, Proposition 2.3] is the crystal embedding defined by the injective map

$$\begin{aligned} \mathbf{E} : \text{KN}(\lambda, n) &\hookrightarrow \text{SSYT}(\lambda^A, 2n) \subseteq \bigotimes_{i=1}^k \mathfrak{B}(\Lambda_i^A + \Lambda_{2n-i}^A, 2n) \\ T = C_1 C_2 \cdots C_k &\mapsto \mathbf{E}(T) = \psi(C_k) \otimes \cdots \otimes \psi(C_1) \\ &= [\emptyset \leftarrow w(\psi(C_k)) \leftarrow \cdots \leftarrow w(\psi(C_1))] \end{aligned}$$

where $w(\psi(C_i))$ is the Chinese/Japanese reading of the two column semistandard tableau $\psi(C_i)$. Then $K(\lambda^A) = \psi(K(\Lambda_{m_1})) \otimes \cdots \otimes \psi(K(\Lambda_{m_k})) = E(K(\lambda))$. Note that according to our conventions $T = C_1 \cdots C_k = C_k \otimes \cdots \otimes C_1 \in \text{KN}(\lambda, n)$ and we have

$$(33) \quad \mathbf{E}(C_k \otimes \cdots \otimes C_1) = \psi(C_k) \otimes \cdots \otimes \psi(C_1).$$

The crystal $E(\text{KN}(\lambda, n))$ is realized by the crystal connected component of $\bigotimes_{i=1}^k \mathfrak{B}(\Lambda_i^A + \Lambda_{2n-i}^A, 2n)$ with highest weight element $K(\lambda^A)$ by acting with lowering operators f_i^E on $K(\lambda^A)$.

One has, $\mathbf{E}f_i(T) = f_i^E \mathbf{E}(T)$, for $T \in \text{KN}(\lambda, n)$, $1 \leq i \leq n$, and length function

$$(34) \quad \varphi_i(T) = \begin{cases} \varphi_i^A(E(T)) = \varphi_{2n-i}^A(E(T)), & 1 \leq i < n \\ 1/2\varphi_n^A(E(T)), & i = n. \end{cases}$$

similarly for $\varepsilon_i(T)$ where $\varphi_i^A, \varepsilon_i^A$ denote the length functions in $\text{SSYT}(\lambda^A, 2n)$. From (34), the following observations follow.

Remark 7.1. (a) For $1 \leq i < n$,

$$\begin{aligned} \langle \lambda, \alpha_i \rangle &= \lambda_i - \lambda_{i+1} = \varphi_i(K(\lambda)) \\ &= \varphi_i^A(K(\lambda^A)) = \langle \lambda^A, \alpha_i \rangle = \lambda_i^A - \lambda_{i+1}^A \\ &= \varphi_{2n-i}^A(K(\lambda^A)) = \langle \lambda^A, \alpha_{2n-i} \rangle = \lambda_{2n-i}^A - \lambda_{2n-i+1}^A. \end{aligned}$$

For $i = n$,

$$\lambda_n^A - \lambda_{n+1}^A = \langle \lambda^A, \alpha_n \rangle = \varphi_n^A(K(\lambda^A)) = 2\varphi_n(K(\lambda)) = 2\langle \lambda, e_n \rangle = 2\lambda_n = 2\langle \lambda, \alpha_n^\vee \rangle.$$

Therefore the stabilizer of $\lambda \in \mathcal{P}_n$ under the action of B_n is identified with the stabilizer of $\lambda^A \in \mathcal{P}_{2n-1}$ under the action of $B_n^A (\subseteq \mathfrak{S}_{2n})$, and $B_n^\lambda = B_n^{A, \lambda^A}$.

(b) For $u \in \mathfrak{S}_{2n}\lambda^A$, and $1 \leq i < n$,

$$\begin{aligned} \varphi_i^A(K(u)) &= \langle u, \alpha_i \rangle = \varphi_i^A(K(s_{2n-i}^A u)) = \langle s_{2n-i}^A u, \alpha_i \rangle, \\ \varphi_{2n-i}^A(K(u)) &= \langle u, \alpha_{2n-i} \rangle = \varphi_{2n-i}^A(K(s_i^A u)) = \langle s_i^A u, \alpha_{2n-i} \rangle. \\ u < s_i^A u &\Leftrightarrow s_{2n-i}^A u < s_i^A s_{2n-i}^A u \\ u < s_{2n-i}^A u &\Leftrightarrow s_i^A u < s_{2n-i}^A s_i^A u \end{aligned}$$

Let $O_{B_n}(\lambda^A) = \{K(u^A) : u^A \in B_n^A \lambda^A\}$ be the B_n -orbit of λ^A , where B_n is identified with $\langle s_i^A s_{2n-i}^A, s_n^A, 1 \leq i < n \rangle \subseteq \mathfrak{S}_{2n}$, and $O_{\mathfrak{S}_{2n}}(\lambda^A) = \{K(u) : \mu \in \mathfrak{S}_{2n} \lambda^A\}$ the \mathfrak{S}_{2n} -orbit of λ^A . Indeed

$$O_{B_n}(\lambda^A) \subseteq O_{\mathfrak{S}_{2n}}(\lambda^A).$$

Remark 7.2. Recall, for any $1 \leq i \leq 2n-1$, $f_i^{A \max}(T) := f_i^{A \varphi_i^A(T)}(T)$ for $T \in \text{SSYT}(\lambda^A, 2n)$. For $T \in \text{KN}(\lambda, n)$, from (32), (34),

$$\begin{aligned} E(f_i^{\max}(T)) &= E(f_i^{\varphi_i(T)}(T)) = f_{2n-i}^A{}^{\varphi_i(T)} f_i^{A \varphi_i(T)}(E(T)) \\ &= f_{2n-i}^A{}^{\varphi_{2n-i}^A(E(T))} f_i^{A \varphi_i^A(E(T))}(E(T)) = f_i^{A \max} f_{2n-i}^{A \max}(E(T)), \text{ for } 1 \leq i < n, \end{aligned}$$

and

$$\begin{aligned} E(f_n^{\max}(T)) &= E(f_n^{\varphi_n(T)}(T)) = f_n^{A 2 \varphi_n(T)} \\ &= f_n^{A \varphi_n^A(E(T))}(E(T)) = f_n^{A \max}(E(T)). \end{aligned}$$

Therefore, for $T \in \text{KN}(\lambda, n)$, we define

$$f_i^{E \max}(E(T)) = \begin{cases} f_i^{A \max} f_{2n-i}^{A \max}(E(T)), & \max = \varphi_i(T) = \varphi_{2n-i}^A(E(T)) = \varphi_i^A(E(T)), 1 \leq i < n \\ f_n^{A \max}(E(T)), & \max = \varphi_n^A(E(T)) = 2\varphi_n(T), i = n, \end{cases}$$

and $E(f_i^{\max}(T)) = f_i^{E \max}(E(T))$, $1 \leq i \leq n$.

7.2. Baker embedding of symplectic keys into \mathfrak{gl}_{2n} keys: virtual keys and virtual Demazure crystals. We show that the injection E embeds the keys of $\text{KN}(\lambda, n)$, that is, the keys in $O(\lambda)$ into the keys in $O_{\mathfrak{S}_{2n}}(\lambda^A)$ restricted to $O_{B_n^A}(\lambda^A)$. More precisely, $E(O(\lambda)) = O_{B_n^A}(\lambda^A)$. However the injection E does not need to send a Demazure crystal of $\text{KN}(\lambda, n)$ to a Demazure crystal of $\text{SSYT}(\lambda^A, 2n)$ parameterized in $B_n^A \lambda^A$, instead E embeds it inside to a such Demazure crystal of $\text{SSYT}(\lambda^A, 2n)$. More precisely, for $v \in B_n \lambda$, $E(\mathfrak{B}_v) = \mathfrak{B}_{\tilde{v}} \cap \text{KN}(\lambda, n)$, where the map $v = s_{i_r} \cdots s_{i_1} \lambda \mapsto \tilde{v} = \tilde{s}_{i_r} \cdots \tilde{s}_{i_1} \lambda^A$ with $s_{i_r} \cdots s_{i_1} \in W^\lambda = B_n^\lambda$ defines a bijection between $B_n \lambda$ and $B_n^A \lambda^A$.

Lemma 7.3. (1) For $1 \leq j < n$, the following are equivalent

- $\lambda < s_j \lambda$ in $B_n \lambda$.
- $\lambda^A < s_j^A \lambda^A$ in $\mathfrak{S}_{2n} \lambda^A$.
- $\lambda^A < s_{2n-j}^A \lambda^A$ in $\mathfrak{S}_{2n} \lambda^A$.
- $\lambda^A < s_j^A \lambda^A < s_{2n-j}^A s_j^A \lambda^A$
- $\lambda^A < s_{2n-j}^A \lambda^A < s_j^A s_{2n-j}^A \lambda^A$ in $\mathfrak{S}_{2n} \lambda^A$.
- $\lambda^A < \tilde{s}_j \lambda^A$ in $B_n^A \lambda^A$.
- $f_j^{\max}(K(\lambda)) = K(s_j \lambda)$, $\max = \varphi_j(K(\lambda)) = \langle \lambda, \alpha_j \rangle > 0$.
- $f_j^{E \max}(K(\lambda^A)) = K(\tilde{s}_j \lambda^A)$, $\max = \varphi_j(K(\lambda)) = \varphi_{2n-j}^A(K(\lambda^A)) = \varphi_j^A(K(\lambda^A)) = \langle \lambda^A, \alpha_j \rangle = \langle \lambda^A, \alpha_{2n-j} \rangle > 0$.

(2) For $j = n$,

$$\begin{aligned} \lambda < s_n \lambda \text{ in } B_n \lambda &\Leftrightarrow \lambda^A < \tilde{s}_n \lambda^A \text{ in } \mathfrak{S}_{2n} \lambda^A \\ &\Leftrightarrow f_n^{\max}(K(\lambda)) = K(s_n \lambda), \max = \varphi_n(K(\lambda)) > 0 \\ &\Leftrightarrow f_n^{E \max}(K(\lambda^A)) = K(\tilde{s}_n \lambda^A), \max = \varphi_n^A(K(\lambda^A)) = 2\varphi_n(K(\lambda)) > 0. \end{aligned}$$

Proof. (a) Let $1 \leq j < n$. From (34), Proposition 3.6 and Remark 7.1,

$$\begin{aligned} \lambda < s_j \lambda \text{ in } B_n \lambda &\Leftrightarrow 0 < \langle \lambda, \alpha_j \rangle = \varphi_j(K(\lambda)) = \varphi_j^A(K(\lambda^A)) = \langle \lambda^A, \alpha_j \rangle > 0 \\ &\Leftrightarrow \lambda^A < s_j \lambda^A \end{aligned}$$

and

$$\begin{aligned} \lambda^A < s_j \lambda^A &\Leftrightarrow 0 < \langle \lambda^A, \alpha_j \rangle = \varphi_j^A(K(\lambda^A)) = \varphi_{2n-j}^A(K(\lambda^A)) = \langle \lambda^A, \alpha_{2n-j} \rangle > 0 \\ &\Leftrightarrow \lambda^A < s_{2n-j}^A \lambda^A \\ &\Leftrightarrow \lambda^A < s_{2n-j}^A \lambda^A < s_{2n-j}^A s_j^A \lambda^A \\ &\Leftrightarrow \lambda^A < s_j^A \lambda^A < s_j^A s_{2n-j}^A \lambda^A. \end{aligned}$$

We prove now that $\lambda^A < s_{2n-j}^A \lambda^A < s_j^A s_{2n-j}^A \lambda^A \Leftrightarrow \lambda^A < \tilde{s}_j \lambda^A$. It is enough to prove that $\lambda^A < \tilde{s}_j \lambda^A \Rightarrow \lambda < s_j \lambda$. If $\lambda \not< s_j \lambda$ since λ is a partition,

$$\begin{aligned} \lambda = s_j \lambda &\Leftrightarrow \varphi_j(K(\lambda)) = \varphi_j^A(K(\lambda^A)) = \varphi_{2n-j}^A(K(\lambda^A)) = 0 \\ &\Leftrightarrow \langle \lambda^A, \alpha_j \rangle = \langle \lambda^A, \alpha_{2n-j} \rangle = 0 \\ &\Leftrightarrow \lambda^A = s_j \lambda^A, \lambda^A = s_{2n-j} \lambda^A \Leftrightarrow \lambda^A \not< s_j \lambda^A, \lambda^A \not< s_{2n-j} \lambda^A. \end{aligned}$$

Next

$$\begin{aligned} \lambda < s_j \lambda \text{ in } B_n \lambda &\Leftrightarrow \\ &\Leftrightarrow f_j^{\max}(K(\lambda)) = K(s_j \lambda), \max = \varphi_j(T) > 0, \text{ by Lemma 3.6} \\ &\Leftrightarrow E(f_j^{\max}(K(\lambda))) = E(K(s_j \lambda)), \max = \varphi_j(T) > 0, \text{ since } E \text{ is an injection} \\ &\Leftrightarrow f_j^{E \max}(K(\lambda^A)) = f_j^{A \max} f_{2n-j}^{A \max}(K(\lambda^A)) = E(K(s_j \lambda)), \\ &\text{with } \max = \varphi_j(K(\lambda)) = \varphi_{2n-j}^A(K(\lambda^A)) = \varphi_j^A(K(\lambda^A)) > 0, \\ &= f_{2n-j}^{A \max}(K(s_j \lambda^A)) = K(s_{2n-j} s_j \lambda^A) = K(\tilde{s}_j \lambda^A) = E(K(s_j \lambda)), \quad 1 \leq j < n, \end{aligned}$$

(b) Let $j = n$,

$$\begin{aligned} \lambda < s_n \lambda \text{ in } B_n \lambda &\Leftrightarrow f_n^{\max}(K(\lambda)) = K(s_n \lambda), \max = \varphi_n(K(\lambda)) > 0 \\ &\Leftrightarrow f_n^{E \max}(K(\lambda^A)) = f_n^{A \max}(K(\lambda^A)) = K(\tilde{s}_n \lambda^A) = E(K(s_n \lambda)), \\ &\text{with } \max = \varphi_n^A(K(\lambda^A)) = 2\varphi_n(K(\lambda)) > 0, \quad j = n, \text{ by Remark 7.2} \\ &= f_n^{A \max}(K(\lambda^A)) = K(\tilde{s}_n \lambda^A) = E(K(s_n \lambda)), \max > 0, \text{ by Lemma 3.6 and Remark 7.1} \\ &\Leftrightarrow \lambda^A < \tilde{s}_n \lambda^A \text{ in } B_n \lambda^A. \end{aligned}$$

□

The weak Bruhat graph defined by the vertices of $O(\lambda) = \{K(u) : u \in B_n \lambda\}$, in bijection with B_n^λ , and with edges the i -strings connecting them in $\text{KN}(\lambda, n)$ is embedded in $O_{\mathfrak{S}_{2n}}(\lambda^A)$. For $1 \leq i \leq n$ and $u \in B_n \lambda$, there is a non trivial i -chain connecting $K(u)$ to $K(s_i u)$ in $\text{KN}(\lambda, n)$ if and only if $u < s_i u$ in $B_n \lambda$, equivalently $f_i^{\max}(K(u)) = K(s_i u)$ with $\max = \varphi_i(K(u)) = \langle u, \alpha_i^\vee \rangle > 0$. More precisely,

$$O(\lambda) = \{f_{i_r}^{\max} \cdots f_{i_1}^{\max}(K(\lambda)) \mid i_1, \dots, i_r \in [n], r \geq 0\}.$$

We prove that the keys in $\text{KN}(\lambda, n)$ are embedded by E into keys in $\text{SSYT}(\lambda^A, 2n)$. One has $K(\lambda) \in O(\lambda)$ and $E(K(\lambda)) = K(\lambda^A) \in O_{B_n}(\lambda^A)$. More generally, we claim that, $E(O(\lambda)) = O_{B_n}(\lambda^A) \hookrightarrow$

$O_{\mathfrak{S}_{2n}}(\lambda^A)$ such that, for $u \in B_n\lambda$, whenever $\lambda < s_{i_1}\lambda < \cdots < s_{i_r} \cdots s_{i_1}\lambda = u$ for some $s_{i_1}, \dots, s_{i_r} \in B_n$, then $K(u) \mapsto K(u^A)$ with $\lambda^A < \tilde{s}_{i_1}\lambda^A < \cdots < \tilde{s}_{i_r} \cdots \tilde{s}_{i_1}\lambda^A = u^A$.

Proposition 7.4. (1) Let $v \in B_n\lambda$ and $s_{i_1}, \dots, s_{i_r} \in B_n$, $r \geq 0$, such that $s_{i_r} \cdots s_{i_1}\lambda = v$. Then the following are equivalent

- $\lambda < s_{i_1}\lambda < \cdots < s_{i_r} \cdots s_{i_1}\lambda = v$.
 - $E(K(s_{i_r} \cdots s_{i_1}\lambda)) = f_{i_r}^{E^{max}} \cdots f_{i_1}^{E^{max}}(K(\lambda^A)) = K(\tilde{s}\lambda^A) \in O_{B_n}(\lambda^A)$, with $\tilde{s} = \tilde{s}_{i_r} \cdots \tilde{s}_{i_1}$ and every $max > 0$.
 - $\lambda^A < \tilde{s}_{i_1}\lambda^A < \cdots < \tilde{s}_{i_r} \cdots \tilde{s}_{i_1}\lambda^A \in B_n^A\lambda^A$.
- (2) $O_{B_n}(\lambda^A) = \{f_{i_r}^{E^{max}} \cdots f_{i_1}^{E^{max}}(K(\lambda^A)) \mid i_1, \dots, i_r \in [n], r \geq 0\} = E(O(\lambda))$.
The set $O_{B_n}(\lambda^A)$ is called the set of virtual keys of $\text{KN}(\lambda, n)$.

Proof. (a) By induction on $r \geq 0$ with base case $r = 0$ and, by Lemma 7.3, $r = 1$. Let $r > 1$ and suppose the statement true for $r - 1$. Consider $s_{i_{r-1}} \cdots s_{i_1}\lambda =: u \in B_n\lambda$ and $\tilde{s}_{i_{r-1}} \cdots \tilde{s}_{i_1}\lambda^A =: \tilde{u} \in B_n^A\lambda^A$. One has

$$\begin{aligned} u < v = s_{i_r}u \text{ in } B_n\lambda &\Leftrightarrow K(v) = f_{i_r}^{max}K(u), \text{ max} > 0, \text{ by Proposition 3.6} \\ &\Leftrightarrow E(K(v)) = E(f_{i_r}^{max}K(u)), \text{ max} > 0 \\ &\Leftrightarrow E(K(v)) = f_{i_r}^{E^{max}}E(K(u)), \text{ max} > 0 \end{aligned}$$

$$\Leftrightarrow E(K(v)) = f_{i_r}^{E^{max}} f_{i_{r-1}}^{E^{max}} \cdots f_{i_1}^{E^{max}}(K(\lambda^A)), \text{ all max} > 0, \text{ by induction}$$

$$\Leftrightarrow E(K(v)) = f_{i_r}^{E^{max}}K(\tilde{s}_{i_{r-1}} \cdots \tilde{s}_{i_1}\lambda^A), \text{ max} > 0$$

$$\begin{aligned} &\Leftrightarrow E(K(v)) = K(\tilde{s}_{i_r}\tilde{s}_{i_{r-1}} \cdots \tilde{s}_{i_1}\lambda^A) \\ &\Leftrightarrow \tilde{s}_{i_{r-1}} \cdots \tilde{s}_{i_1}\lambda^A < \tilde{s}_{i_r} \cdots \tilde{s}_{i_1}\lambda^A \in B_n^A\lambda^A, \text{ by Proposition 3.6} \\ &\Leftrightarrow \tilde{u} < \tilde{v} = \tilde{s}_{i_r}\tilde{u}. \end{aligned}$$

(b) Follows from (a). □

Remark 7.5. $E(\text{KN}(\lambda, n)) \subseteq \text{SSYT}(\lambda^A, 2n)$ and $f_i^{max}(K(u)) = K(s_i u)$, with $u < s_i u$ if and only if $f_i^{E^{max}}(K(u)) = K(\tilde{s}_i u^A)$, with $u^A < \tilde{s}_i u^A$. This means that there is a i -chain of length $\langle u, \alpha_i \rangle > 0$ in $\text{KN}(\lambda, n)$ connecting $K(u)$ and $K(s_i u)$ if and only if there is a diamond made of two double chains $i, 2n - i$ and $2n - i, i$, each edge of length $\langle u, \alpha_i \rangle > 0$, connecting $E(K(u)) = K(u^A)$ and $\tilde{s}_i K(u^A)$ in $\text{SSYT}(\lambda^A, 2n)$. There is a n -chain of length $\langle u, \alpha_n^\vee \rangle > 0$ connecting $K(u)$ and $K(s_n u)$ in $\text{KN}(\lambda, n)$ if and only if there is a n, n -double chain of length $2\langle u, \alpha_n^\vee \rangle > 0$ connecting $K(u^A)$ and $\tilde{s}_n K(u^A) = E(f_n^{max}(K(u))) = (f_n^A)^{\langle u, \alpha_n^\vee \rangle} (f_n^A)^{\langle u, \alpha_n^\vee \rangle} K(u^A)$ in $\text{SSYT}(\lambda^A, 2n)$. See Example 7.11.

Let $s_{i_r} \cdots s_{i_1}$ be a reduced word in B_n^λ , $v = s_{i_r} \cdots s_{i_1}\lambda \in B_n\lambda$, and $\tilde{v} = \tilde{s}_{i_r} \cdots \tilde{s}_{i_1}\lambda^A \in B_n\lambda^A$, where $\tilde{s}_{i_r} \cdots \tilde{s}_{i_1}$ is also a reduced word in B_n^{A, λ^A} (and also in $\mathfrak{S}_{2n}^{\lambda^A}$). Then

$$(35) \quad \mathfrak{B}_v = \{f_{i_r}^{k_r} \cdots f_{i_1}^{k_1}(K(\lambda)) \mid (k_r, \dots, k_1) \in \mathbb{Z}_{\geq 0}^r \setminus \{0\} \subseteq \text{KN}(\lambda, n)\},$$

and

$$\begin{aligned}
E(\mathfrak{B}_v) &= \{(f_{i_r}^E)^{k_r} \cdots (f_{i_1}^E)^{k_1}(K(\lambda^A)) \mid (k_r, \dots, k_1) \in \mathbb{Z}_{\geq 0}^\ell\} \setminus \{0\} \\
&= \{(f_{i_r}^A)^{k_r} (f_{2n-i_r}^A)^{k_r} \cdots (f_{i_1}^A)^{k_1} (f_{2n-i_1}^A)^{k_1}(K(\lambda^A)) \mid (k_r, \dots, k_1) \in \mathbb{Z}_{\geq 0}^\ell\} \setminus \{0\} \\
&\subseteq \{(f_{i_r}^A)^{k_r} (f_{2n-i_r}^A)^{k'_r} \cdots (f_{i_1}^A)^{k_1} (f_{2n-i_1}^A)^{k'_1}(K(\lambda^A)) \mid (k_r, k'_r, \dots, k_1, k'_1) \in \mathbb{Z}_{\geq 0}^\ell\} \setminus \{0\} \\
&= \mathfrak{B}_{\tilde{v}}^A \subseteq \text{SSYT}(\lambda^A, 2n) \text{ where } \tilde{v} = \tilde{s}_{i_r} \cdots \tilde{s}_{i_1} \lambda^A \in B_n \lambda^A.
\end{aligned}$$

For each $v \in B_n \lambda$, the injection E embeds the Demazure crystal $\mathfrak{B}_v \subseteq \text{KN}(\lambda, n)$ into the Demazure crystal $\mathfrak{B}_{\tilde{v}}^A \subseteq \text{SSYT}(\lambda^A, 2n)$ with $\tilde{v} \in B_n \lambda^A$. Henceforth, recalling (31), we have the following assertion.

Proposition 7.6. *With the setup above, $E(\mathfrak{B}_v) = \mathfrak{B}_{\tilde{v}}^A \cap E(\text{KN}(\lambda, n))$.*

The *virtual Demazure crystals* of $\text{KN}(\lambda, n)$ are $E(\mathfrak{B}_v) = \mathfrak{B}_{\tilde{v}}^A \cap E(\text{KN}(\lambda, n))$, for all $\tilde{v} \in B_n \lambda^A$. Note $\mathfrak{B}_{s_r \cdots s_1 \lambda^A}^A, \mathfrak{B}_{s_{2n-r} \cdots s_{2n-1} \lambda^A}^A \subseteq \mathfrak{B}_{\tilde{v}}^A$ as Demazure crystals of $\text{SSYT}(\lambda^A, 2n)$ whereas this containment does not happen in $E(\text{KN}(\lambda, n))$.

7.3. Baker embedding and crystal dilatation commute. Recall § 3.4 and Proposition 3.8, ([21, Proposition 8.3.2]). Given a positive integer m , there is a unique embedding of (abstract) crystals $\mathfrak{B}(\lambda) \hookrightarrow \mathfrak{B}(m\lambda)$ such that for any vertex $b \in \mathfrak{B}(\lambda)$ and any path $b = f_{i_1} \cdots f_{i_l}(b_\lambda)$ in $\mathfrak{B}(\lambda)$

$$(36) \quad \theta_m(b) = f_{i_l}^m \cdots f_{i_1}^m(b_{m\lambda}).$$

In particular, for $\sigma \in W^\lambda$, $\theta_m(b_{\sigma\lambda}) = b_{\sigma m\lambda}$, that is, $\theta_m(O(\lambda)) = O(m\lambda)$. Furthermore, $\varphi_i(\theta_m(b)) = m\varphi_i(b)$, $\varepsilon_i(\theta_m(b)) = m\varepsilon_i(b)$ and $\text{wt}(\theta_m(b)) = m\text{wt}(b)$, for $i \in I$. This embedding is called *m-dilatation map*. Since $b_{m\lambda}$ and $b_\lambda^{\otimes m}$ have the same weight $m\lambda$, we may realize this dilatation θ_m in a canonical way as a crystal embedding of $\mathfrak{B}(\lambda)$ into the connected component of $\mathfrak{B}(\lambda)^{\otimes m}$ of highest weight $m\lambda$,

$$(37) \quad \theta_m : \begin{cases} \mathfrak{B}(b_\lambda) \hookrightarrow \mathfrak{B}(b_\lambda^{\otimes m}) \subset \mathfrak{B}(b_\lambda)^{\otimes m} \\ b \longmapsto b_1 \otimes \cdots \otimes b_m \end{cases}$$

When m has enough factors (in general, m is equal to the least common multiple of the maximal lengths of the i -chains in $\mathfrak{B}(\lambda)$), the m -dilatation map on $\mathfrak{B}(b_\lambda)$ transform the vertices into a tensor product of m keys in $O(\lambda)$,

$$(38) \quad \theta_m : \begin{cases} \mathfrak{B}(\lambda) \hookrightarrow \mathfrak{B}(K(\lambda)^{\otimes m}) \subset \mathfrak{B}(\lambda)^{\otimes m} \\ b \longmapsto K(\sigma_1 \lambda) \otimes \cdots \otimes K(\sigma_m \lambda) \end{cases}$$

where $\sigma_1 \geq \dots \geq \sigma_m$ in W^λ , $K^+(b) = K(\sigma_1 \lambda)$ and $K^-(b) = K(\sigma_m \lambda)$. It is important, to recall that the elements $K(\sigma_1 \lambda)$ and $K(\sigma_m \lambda)$ in $\theta_m(T)$ do not then depend on m , once we get one m that sends, via θ_m , all $T \in \mathfrak{B}(\lambda)$ to a tensor product of keys in $\mathfrak{B}(\lambda)$.

That is, the dilated crystal $\theta_m(\mathfrak{B}(\lambda))$ is generated in $\mathfrak{B}(m\lambda)$ (equivalently in $\mathfrak{B}(K(\lambda)^{\otimes m})$) by acting successively with f_i^m on $K(m\lambda)$ (equivalently $K(\lambda)^{\otimes m}$) for $i \in I$,

$$\theta_m(\mathfrak{B}(\lambda)) = \{f_{i_l}^m \cdots f_{i_1}^m(K(m\lambda)) : (i_l, \dots, i_1) \in [n]^l, l \geq 0\} \setminus \{0\} \subseteq \mathfrak{B}(m\lambda, n),$$

and the generated vertices in $\mathfrak{B}(K(\lambda)^{\otimes m}) \subseteq \mathfrak{B}(K(\lambda))^{\otimes m}$ are tensor product of keys of $\mathfrak{B}(\lambda)$ such that the leftmost and rightmost keys in this factorization are the right key and the left key respectively of the corresponding vertex in $\mathfrak{B}(\lambda)$. Each i -directed edge in $\mathfrak{B}(\lambda)$ corresponds to a $\underbrace{i, \dots, i}_{m}$ -directed edge in $\theta_m(\mathfrak{B}(\lambda)) \subseteq \mathfrak{B}(K(\lambda)^{\otimes m}) \simeq \mathfrak{B}(m\lambda)$ and vice-versa. See Figure 2 where the dilated crystal

$\theta_6(\text{KN}((2, 1), 2)) = \{f_{i_1}^6 \cdots f_{i_1}^6(K((12, 6))) \mid i_1, \dots, i_l \in [1, 2] \setminus \{0\} \subseteq \text{KN}((12, 6), 2)$ each directed edge is defined by the dilated lowering operator f_i^6 when defined.

Remark 7.7. By induction on $l \geq 0$, the base case $l = 0$ gives $\theta_m(K(\lambda)) = K(\lambda)^{\otimes m}$. Furthermore, if $f_{i_1} \cdots f_{i_l}(K(\lambda)) = T$ in $\text{KN}(\lambda, n)$, then

$$(39) \quad \begin{aligned} \theta_m(T) &= f_{i_1}^m \cdots f_{i_l}^m(K(\lambda^{\otimes m})) = K(\sigma_1 \lambda) \otimes \cdots \otimes K(\sigma_m \lambda) \\ &= K^+(T) \otimes K(\sigma_2 \lambda) \otimes \cdots \otimes K(\sigma_{m-1} \lambda) \otimes K^-(T) \text{ in } \mathfrak{B}(K(\lambda^{\otimes m})) \simeq \text{KN}(m\lambda, n), \end{aligned}$$

with $\sigma_1 \geq \sigma_2 \geq \cdots \geq \sigma_m$ in B_n^λ . Then $K^+(T) = K(\sigma_1 \lambda)$ and $K^-(T) = K(\sigma_m \lambda)$. In particular, $\theta_m(K(s_i \lambda)) = \theta_m(f_i^{\max}(K(\lambda))) = f_i^{\max m}(K(\lambda)^{\otimes m}) = K(s_i \lambda)^{\otimes m}$, where $\max = \varphi_i(K(\lambda))$. More generally, from (6), (7), $\theta_m(K(\sigma \lambda)) = K(\sigma \lambda)^{\otimes m}$ for $\sigma \in B_n^\lambda$.

Consider the setting of §7.1 and the following proposition.

Proposition 7.8. [21, Corollaire 8.1.6] *Let λ and μ two dominant weights. If $V(\nu)$ appears in $V(\lambda) \otimes V(\mu)$ then $V(m\nu)$ appears in $V(m\lambda) \otimes V(m\mu)$ for any positive integer m .*

Since $\text{SSYT}(\lambda^A, 2n) \subseteq \bigotimes_{i=1}^k \text{SSYT}(\Lambda_i^A + \Lambda_{2n-i}^A, 2n)$ then

$$\text{SSYT}(m\lambda^A, 2n) \subseteq \bigotimes_{i=1}^k \text{SSYT}(m(\Lambda_i^A + \Lambda_{2n-i}^A), 2n)$$

where $m\lambda^A = \sum_{i=1}^k m(\Lambda_i^A + \Lambda_{2n-i}^A) = m \sum_{i=1}^k (\Lambda_i^A + \Lambda_{2n-i}^A)$ for any integer $m > 0$.

In what follows we denote by θ_m the m -dilatation map either on $\text{KN}(m\lambda, n)$ or on $\text{SSYT}(\lambda^A, 2n)$. One then has, by definition of θ_m and E ,

$$(40) \quad \begin{aligned} \text{KN}(m\lambda, n) &\xleftrightarrow{\theta_m} \text{KN}(m\lambda, n) \\ T = f_{i_1} \cdots f_{i_l}(K(\lambda)) &\mapsto \theta_m(T) = f_{i_1}^m \cdots f_{i_l}^m(K(m\lambda)) \\ \text{KN}(m\lambda, n) &\xleftrightarrow{E} \text{SSYT}(m\lambda^A, 2n) \\ \theta_m(T) = f_{i_1}^m \cdots f_{i_l}^m(K(m\lambda)) &\mapsto E\theta_m(T) = f_{i_1}^{Am} (f_{2n-i_1}^A)^m \cdots f_{i_l}^{Am} (f_{2n-i_l}^A)^m (K(m\lambda^A)) \end{aligned} ,$$

On the other hand,

$$(41) \quad \begin{aligned} \text{KN}(\lambda, n) &\xleftrightarrow{E} \text{SSYT}(\lambda^A, 2n) \\ T = f_{i_1} \cdots f_{i_l}(K(\lambda)) &\mapsto E(T) = f_{i_1}^A f_{2n-i_1}^A \cdots f_{i_l}^A f_{2n-i_l}^A (K(\lambda^A)) \\ \text{SSYT}(\lambda^A, 2n) &\xleftrightarrow{\theta_m} \text{SSYT}(m\lambda^A, 2n) \\ E(T) &\mapsto \theta_m E(T) = f_{i_1}^{Am} (f_{2n-i_1}^A)^m \cdots f_{i_l}^{Am} (f_{2n-i_l}^A)^m (K(m\lambda^A)) \end{aligned} ,$$

where $E(T) = f_{i_1}^A f_{2n-i_1}^A \cdots f_{i_l}^A f_{2n-i_l}^A (K(\lambda^A))$ in $E(\text{KN}(\lambda, n))$

Therefore, from (40) and (41),

$$\theta_m(E(T)) = f_{i_1}^{Am} (f_{2n-i_1}^A)^m \cdots f_{i_l}^{Am} (f_{2n-i_l}^A)^m (K(\lambda^A)^{\otimes m}) = E(\theta_m(T)).$$

It then follows

Proposition 7.9. *The injections θ_m and E commute in $\text{KN}(\lambda, n)$: $\theta_m E = E\theta_m$.*

$$\begin{array}{ccc} \text{KN}(\lambda, n) & \xrightarrow{\theta_m} & \text{KN}(m\lambda, n) \\ \downarrow E & & \downarrow E \\ \text{SSYT}(\lambda^A, 2n) & \xrightarrow{\theta_m} & \text{SSYT}(m\lambda^A, 2n) \end{array}$$

7.4. Baker embedding and right and left key maps commute. We show that the composition of the Baker embedding E with the C_n right (respect. left) key map K^+ (respect. K^-) is equal to the composition of the A_{2n-1} right (respect. left) key map with the Baker embedding E . That is, that for all $T \in \text{KN}(\lambda, n)$, $E(K^+(T)) = K^+(E(T))$ and $E(K^-(T)) = K^-(E(T))$. Henceforth, $K_+(T) = E^{-1}(K_+(E(T)))$ and $K^-(T) = E^{-1}(K^-(E(T)))$ where E^{-1} is the reverse of Baker embedding using the type A_{2n-1} reverse column Schensted insertion [2].

Theorem 7.10. (a) *Let m be a positive integer such that, for each $T \in \text{KN}(\lambda, n)$, the m -dilatation map θ_m on $\text{KN}(\lambda, n)$ gives $\theta_m(T) = K(\sigma_1\lambda) \otimes \cdots \otimes K(\sigma_m\lambda)$ for some $\sigma_1 \geq \cdots \geq \sigma_m$ in B_n^λ . Then*

$$(42) \quad \theta_m(E(T)) = E(\theta_m(T)) = E(K(\sigma_1\lambda)) \otimes \cdots \otimes E(K(\sigma_m\lambda)) = K(\tilde{\sigma}_1\lambda^A) \otimes \cdots \otimes K(\tilde{\sigma}_m\lambda^A),$$

where $E(K(\sigma_i\lambda)) = K(\tilde{\sigma}_i\lambda^A) \in O_{B_n^A}(\lambda^A)$, $1 \leq i \leq m$.

(b) $E(K^+(T)) = K^+(E(T))$ and $E(K^-(T)) = K^-(E(T))$ for all $T \in \text{KN}(\lambda, n)$.

Proof. (a) Let $r \geq 0$, $T = f_{i_r} \cdots f_{i_1}(K(\lambda))$ and $\theta_m(T) = K(\sigma_1\lambda) \otimes \cdots \otimes K(\sigma_m\lambda)$ with $\sigma_1 \geq \cdots \geq \sigma_m$ in B_n^λ . That is, by the assumption of our statement, the m -dilatation map θ_m on $\text{KN}(\lambda, n)$ satisfies

$$(43) \quad \theta_m : \begin{cases} \text{KN}(\lambda, n) \hookrightarrow \mathfrak{B}(K(\lambda)^{\otimes m}) \subset \text{KN}(\lambda, n)^{\otimes m} \\ T \mapsto K(\sigma_1\lambda) \otimes \cdots \otimes K(\sigma_m\lambda) \end{cases}$$

where $\sigma_1 \geq \cdots \geq \sigma_m$ in B_n^λ .

The proof of (42) is by induction on $r \geq 0$. For $r = 0$,

$$\begin{aligned} \theta_m(E(K(\lambda))) &= \theta_m(K(\lambda^A)) = K(\lambda^A)^{\otimes m}, \text{ by the property of } m\text{-dilatation on keys, Theorem 3.8, (a)} \\ &= E(\theta_m(K(\lambda))) = E(K(\lambda)^{\otimes m}), \text{ by Proposition 7.9} \end{aligned}$$

$$(44) \quad \Rightarrow \theta_m(E(K(\lambda))) = E(K(\lambda)^{\otimes m}) = K(\lambda^A)^{\otimes m} = E(K(\lambda))^{\otimes m}.$$

Assume by induction on $r \geq 0$, with base case $r = 0$ (44), that (42) holds

$$\begin{aligned} \theta_m(E(T)) &= E(\theta_m(T)) = E(K(\sigma_1\lambda) \otimes \cdots \otimes K(\sigma_m\lambda)) \\ &= E(K(\sigma_1\lambda)) \otimes \cdots \otimes E(K(\sigma_m\lambda)) \text{ by induction} \\ (45) \quad &= K(\tilde{\sigma}_1\lambda^A) \otimes \cdots \otimes K(\tilde{\sigma}_m\lambda^A), \text{ by Proposition 7.4} \\ &\text{with } \tilde{\sigma}_1 \geq \cdots \geq \tilde{\sigma}_m \text{ in } B_n^{A, \lambda^A}. \end{aligned}$$

Let $f_j(T) \neq 0$, for some $1 \leq j \leq n$. Then, by definition of the m -dilatation map θ_m on $\text{KN}(\lambda, n)$, (43), there exists

$$(46) \quad 1 \leq q_1 < \cdots < q_t \leq m,$$

with $\langle \sigma_{q_i} \lambda, \alpha_j^\vee \rangle = \varphi_j(K(\sigma_{q_i} \lambda)) > 0$, $1 \leq i \leq t$,

$$\sum_{1 \leq i \leq t} \langle \sigma_{q_i} \lambda, \alpha_j^\vee \rangle = m, \text{ and } \sigma_1 \geq \cdots \geq s_j \sigma_{q_1} \geq \cdots \geq s_j \sigma_{q_t} \geq \cdots \geq \sigma_m \text{ in } B_n^\lambda,$$

such that

$$\begin{aligned} \theta_m(f_j(T)) &= f_j^m \theta_m(T) = f_j^m(K(\sigma_1 \lambda) \otimes \cdots \otimes K(\sigma_m \lambda)) \\ &= K(\sigma_1 \lambda) \otimes \cdots \otimes K(s_j \sigma_{q_1} \lambda) \otimes \cdots \otimes K(s_j \sigma_{q_t} \lambda) \otimes \cdots \otimes K(\sigma_m \lambda). \end{aligned}$$

Therefore, considering the m -dilatation map θ_m on $\text{SSYT}(\lambda^A, 2n)$,

$$\begin{aligned} \theta_m E(f_j(T)) &= \theta_m f_j^E E(T) = (f_j^E)^m \theta_m E(T) \text{ by (36)} \\ &= (f_j^E)^m (K(\tilde{\sigma}_1 \lambda^A) \otimes \cdots \otimes K(\tilde{\sigma}_m \lambda^A)), \text{ by induction on } r \geq 0, \text{ (45)} \\ (47) \quad &= \begin{cases} (f_j^A)^m (f_{2n-j}^A)^m (K(\tilde{\sigma}_1 \lambda^A) \otimes \cdots \otimes K(\tilde{\sigma}_m \lambda^A)), & 1 \leq j < n \\ (f_n^A)^2 (K(\tilde{\sigma}_1 \lambda^A) \otimes \cdots \otimes K(\tilde{\sigma}_m \lambda^A)), & j = n. \end{cases} \end{aligned}$$

For $\sigma \in B_n$ ($\tilde{\sigma} \in B_n^A$) and $1 \leq i \leq n$, one has by (2)

$$(48) \quad \langle \sigma \lambda, \alpha_i^\vee \rangle = \langle \text{wt}(K(\sigma \lambda)), \alpha_i^\vee \rangle = \begin{cases} \langle \sigma \lambda, \alpha_i \rangle = \varphi_i(K(\sigma \lambda)) - \varepsilon_i(K(\sigma \lambda)), & 1 \leq i < n \\ \langle \sigma \lambda, e_n \rangle = \varphi_n(K(\sigma \lambda)) - \varepsilon_n(K(\sigma \lambda)), & i = n, \end{cases}$$

by (34)

$$= \begin{cases} \varphi_i^A(EK(\sigma \lambda)) - \varepsilon_i^A(EK(\sigma \lambda)) = \varphi_{2n-i}^A(EK(\sigma \lambda)) - \varepsilon_{2n-i}^A(EK(\sigma \lambda)), & 1 \leq i < n \\ 1/2[\varphi_n^A(EK(\sigma \lambda)) - \varepsilon_n^A(EK(\sigma \lambda))], & i = n, \end{cases}$$

by Proposition 7.4,

$$= \begin{cases} \varphi_i^A(K(\tilde{\sigma} \lambda^A)) - \varepsilon_i^A(K(\tilde{\sigma} \lambda^A)) = \varphi_{2n-i}^A(K(\tilde{\sigma} \lambda^A)) - \varepsilon_{2n-i}^A(K(\tilde{\sigma} \lambda^A)), & 1 \leq i < n \\ 1/2[\varphi_n^A(K(\tilde{\sigma} \lambda^A)) - \varepsilon_n^A(K(\tilde{\sigma} \lambda^A))], & i = n, \end{cases}$$

by (2)

$$= \begin{cases} \langle \tilde{\sigma} \lambda^A, \alpha_i^A \rangle = \langle \tilde{\sigma} \lambda^A, \alpha_{2n-i}^A \rangle, & 1 \leq i < n \\ 1/2 \langle \tilde{\sigma} \lambda^A, \alpha_n^A \rangle, & i = n. \end{cases}$$

To compute $(f_j^E)^m(\theta_m E(T))$ (47), we need to apply the tensor product rule in (6) and (7), and from (48), one has

$$\varphi_j^A(\theta_m E(T)) = \begin{cases} \max\{\varphi_j^A(K(\tilde{\sigma}_k \lambda^A)) + \sum_{k < u \leq m} \langle \tilde{\sigma}_u \lambda^A, \alpha_j^A \rangle\} = \\ \max\{\varphi_{2n-j}^A(K(\tilde{\sigma}_k \lambda^A)) + \sum_{k < u \leq m} \langle \tilde{\sigma}_u \lambda^A, \alpha_{2n-j}^A \rangle\}, & 1 \leq j < n, \\ \max\{\varphi_n^A(K(\tilde{\sigma}_k \lambda^A)) + \sum_{k < u \leq m} \langle \tilde{\sigma}_u \lambda^A, \alpha_n^A \rangle\}, & j = n, \end{cases} ,$$

by (48)

$$(49) \quad = \begin{cases} \max\{\varphi_j(K(\sigma_k \lambda)) + \sum_{k < u \leq m} \langle \sigma_u \lambda, \alpha_j \rangle\} = \varphi_j(\theta_m(T)), & 1 \leq j < n, \\ 2 \max\{\varphi_n(K(\sigma_k \lambda)) + \sum_{k < u \leq m} \langle \sigma_u \lambda, e_n \rangle\} = 2\varphi_n(\theta_m(T)), & j = n, \end{cases}$$

Therefore from the tensor product rule the sequence $1 \leq q_1 < q_2 < \cdots < q_t \leq m$ in (46) exists, satisfying

$$\sum_{1 \leq i \leq t} \langle \tilde{\sigma}_{q_i} \lambda^A, \alpha_j^A \rangle = \begin{cases} m, & 1 \leq j < n, \\ 2m, & j = n, \end{cases}$$

and

$$\tilde{\sigma}_1 \geq \cdots \geq \tilde{s}_j \tilde{\sigma}_{q_1} \geq \cdots \geq \tilde{s}_j \tilde{\sigma}_{q_t} \geq \cdots \geq \tilde{\sigma}_m \text{ in } B_n^{A, \lambda^A},$$

such that

$$\begin{aligned} & (f_{2n-j}^A)^m (f_j^A)^m (K(\tilde{\sigma}_1 \lambda^A) \otimes \cdots \otimes K(\tilde{\sigma}_m \lambda^A)) = \\ &= f_{2n-j}^A{}^m (K(\tilde{\sigma}_1 \lambda^A) \otimes \cdots \otimes K(s_j^A \tilde{\sigma}_{q_1} \lambda^A) \otimes \cdots \otimes K(s_j^A \tilde{\sigma}_{q_t} \lambda^A)) \otimes \cdots \otimes K(\tilde{\sigma}_m \lambda^A) \\ &= K(\tilde{\sigma}_1 \lambda^A) \otimes \cdots \otimes K(s_{2n-j}^A s_j^A \tilde{\sigma}_{q_1} \lambda^A) \otimes \cdots \otimes K(s_{2n-j}^A s_j^A \tilde{\sigma}_{q_t} \lambda^A) \otimes \cdots \otimes K(\tilde{\sigma}_m \lambda^A) \\ &= EK(\sigma_1 \lambda) \otimes \cdots \otimes EK(s_j \sigma_{q_1} \lambda) \otimes \cdots \otimes EK(s_j \sigma_{q_t} \lambda) \otimes \cdots \otimes EK(\sigma_m \lambda) \text{ by Proposition 7.4} \end{aligned}$$

and

$$\begin{aligned} & (f_n^A)^{2m} (K(\tilde{\sigma}_1 \lambda^A) \otimes \cdots \otimes K(\tilde{\sigma}_m \lambda^A)) = \\ &= K(\tilde{\sigma}_1 \lambda^A) \otimes \cdots \otimes K(s_n^A \tilde{\sigma}_{q_1} \lambda^A) \otimes \cdots \otimes K(s_n^A \tilde{\sigma}_{q_t} \lambda^A) \otimes \cdots \otimes K(\tilde{\sigma}_m \lambda^A) \\ &= EK(\sigma_1 \lambda) \otimes \cdots \otimes EK(s_n \sigma_{q_1} \lambda) \otimes \cdots \otimes EK(s_n \sigma_{q_t} \lambda) \otimes \cdots \otimes EK(\sigma_m \lambda). \end{aligned}$$

Thus

$$\begin{aligned} \theta_m E(f_j(T)) &= E\theta_m(f_j(T)) \\ &= \begin{cases} E(K(\sigma_1 \lambda) \otimes \cdots \otimes K(s_j \sigma_{q_1} \lambda) \otimes \cdots \otimes K(s_j \sigma_{q_t} \lambda)) \otimes \cdots \otimes K(\sigma_m \lambda), & 1 \leq j < n, \\ EK(\sigma_1 \lambda) \otimes \cdots \otimes K(s_n \sigma_{q_1} \lambda) \otimes \cdots \otimes K(s_n \sigma_{q_t} \lambda) \otimes \cdots \otimes K(\sigma_m \lambda), & j = n. \end{cases} \\ &= \begin{cases} EK(\sigma_1 \lambda) \otimes \cdots \otimes EK(s_j \sigma_{q_1} \lambda) \otimes \cdots \otimes EK(s_j \sigma_{q_t} \lambda) \otimes \cdots \otimes EK(\sigma_m \lambda), & 1 \leq j < n, \\ EK(\sigma_1 \lambda) \otimes \cdots \otimes EK(s_n \sigma_{q_1} \lambda) \otimes \cdots \otimes EK(s_n \sigma_{q_t} \lambda) \otimes \cdots \otimes EK(\sigma_m \lambda), & j = n. \end{cases} \end{aligned}$$

Thereby $K^+(E(f_j(T))) = EK^+(f_j(T))$ and $K^-(E(f_j(T))) = EK^-(f_j(T))$ from which (b) follows. \square

Example 7.11. Let $T \in \text{SSYT}(\lambda^A, 2n)$. If $K^+(T) \in O_{B_n}(\lambda^A)$ we may not conclude that $T \in E(\text{KN}(\lambda, n))$. For example, below, on the left one has the crystal $\text{KN}((1,0), 2) = O(B_2)$, in the middle the virtual crystal $E\text{KN}((1,0), 2) = O(B_2^A)$ and on the right its embedding on the crystal

$\text{SSYT}(\lambda^A = (2, 1, 1), 4)$.

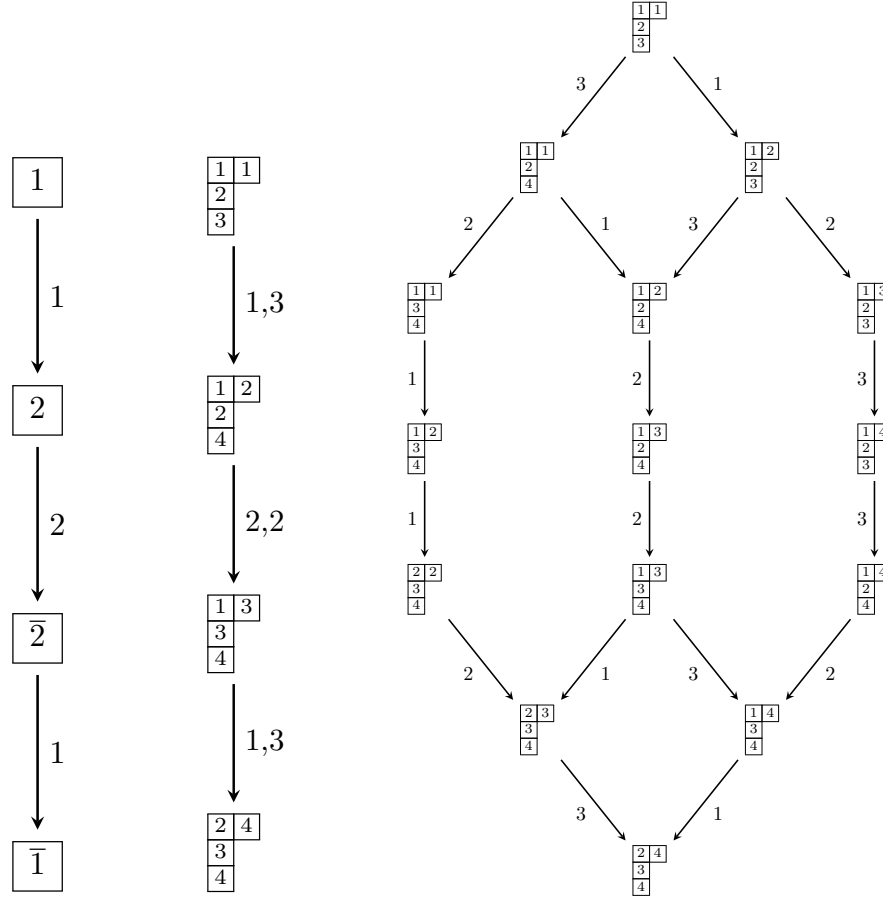

In the crystal $\text{SSYT}(\lambda^A = (2, 1, 1), 4)$ the tableaux

$$S = \begin{array}{|c|c|} \hline 1 & 3 \\ \hline 2 & \\ \hline 4 & \\ \hline \end{array}, \quad T = \begin{array}{|c|c|} \hline 1 & 3 \\ \hline 3 & \\ \hline 4 & \\ \hline \end{array} = E(\bar{2}) \in EKN((1, 0), 2)$$

have the same right key $K^+(S) = K^+(T) = K^-(T) = T \in O(B_2^A)$ while $S \notin EKN((1, 0), 2) = O(B_2^A)$. See also [12, Fig. 5.3].

Remark 7.12. If m has enough factors (in general at least equal to the least comom multiple of the i -string lengths of $\text{KN}(\lambda, n)$), θ_m defines a bijection between the Kashiwara crystal $\text{KN}(\lambda, n)$ and the crystal $\mathbf{B}(\lambda)$ of L-S paths of shape λ as B_n -paths where each vertex of $\theta_m(\text{KN}(\lambda, n))$, $K(\tau_0\lambda)^{\otimes x_0} \otimes (K(\tau_1\lambda))^{\otimes x_1} \geq \dots \otimes (K(\tau_r\lambda))^{\otimes x_r}$ such that $\tau_0 > \dots > \tau_r$ in the Bruhat order in W/W_λ and $x_0 + x_1 + \dots + x_r = m$, provides the L-S path in $\mathbf{B}(\lambda)$ with parameters $(\tau_0 > \tau_1 > \dots > \tau_r; 0 < a_1 = x_0/m < a_2 = a_1 + x_1/m < \dots < a_r = a_{r-1} + x_{r-1}/m < 1 = a_r + x_r/m)$. See Figure 2.

If we consider $M > 0$ a multiple of m and with enough factors (in general at least equal to the least common multiple of the i -string lengths of $\text{SSYT}(\lambda^A, 2n)$) and calculate $\theta_M(\text{SSYT}(\lambda^A, 2n))$ then this dilatation of $\text{SSYT}(\lambda^A, 2n)$ yields bijectively the set $\mathbf{B}(\lambda^A)$ of L-S paths, as \mathfrak{S}_{2n} -paths. As a crystal $\mathbf{B}(\lambda^A)$ is isomorphic to the Kashiwara crystal $\text{SSYT}(\lambda^A, 2n)$ containing $EKN(\lambda, n)$. On the other hand, $\theta_M(EKN(\lambda, n)) = E\theta_M(\text{KN}(\lambda, n))$, and both $\theta_m(\text{KN}(\lambda, n))$ and $\theta_M(\text{KN}(\lambda, n))$ provide the same crystal $\mathbf{B}(\lambda)$ of L-S paths of shape λ , as B_n -paths. Henceforth, the crystal $\mathbf{B}(\lambda)$ of L-S paths

of shape λ , as B_n -paths, is embedded in the crystal $\mathbf{B}(\lambda^A)$ of L-S paths, as \mathfrak{S}_{2n} -paths, where the parameters $\tau_0 > \dots > \tau_r$ are sent to $\tilde{\tau}_0 > \dots > \tilde{\tau}_r$ and the new rational parameters depend on the M -folder tensor products in $\theta_M(\text{SSYT}(\lambda^A, 2n))$. Thanks to Theorem 7.10, E embeds $\mathbf{B}(\lambda)$ into the crystal $\mathbf{B}(\lambda^A)$ of L-S paths as \mathfrak{S}_{2n} -paths, since for $T \in \text{KN}(\lambda, n)$,

$$\begin{aligned} E\theta_M(T) &= E((K(\tau_0\lambda))^{\otimes x'_0} \otimes (K(\tau_1\lambda))^{\otimes x'_1} \otimes \dots \otimes (K(\tau_r\lambda))^{\otimes x'_r}) \\ &= K(\tilde{\tau}_0\lambda)^{\otimes x'_0} \otimes (K(\tilde{\tau}_1\lambda))^{\otimes x'_1} \otimes \dots \otimes (K(\tilde{\tau}_r\lambda))^{\otimes x'_r} = \theta_M(E(T)) \in \theta_M(\text{KN}(\lambda, n)), \end{aligned}$$

where $\tilde{\tau}_i \in B_n^A(\lambda^A)$.

7.5. Virtual symplectic right and left keys examples.

7.5.1. *Baker virtualization of the symplectic Kashiwara crystal.* Consider $n = 5$, and the KN tableau T of shape $\lambda = \Lambda_4 + \Lambda_3 = (2, 2, 2, 1, 0)$ in $\text{KN}(\Lambda_4 + \Lambda_3, 5)$,

$$T = \begin{array}{|c|c|} \hline 1 & 2 \\ \hline 3 & \bar{5} \\ \hline \bar{4} & \bar{3} \\ \hline \bar{3} & \\ \hline \end{array}, \quad \text{wt}(T) = (1, 1, -1, -1, -1).$$

Labelling the columns of T from left to right as C_1 and C_2 , we obtain $E(T)$ with shape $\lambda^A = \Lambda_7^A + \Lambda_3^A + \Lambda_6^A + \Lambda_4^A$ where for convenience we consider the alphabet $[2n]$ represented by $\{1 < 2 < \dots < n < \bar{n} < \dots < \bar{1}\}$:

$$(50) \quad \psi(C_2) = \begin{array}{|c|c|} \hline 1 & 2 \\ \hline 2 & \bar{5} \\ \hline 4 & \bar{3} \\ \hline \bar{5} & \\ \hline \bar{4} & \\ \hline \bar{3} & \\ \hline \bar{1} & \\ \hline \end{array}, \quad \psi(C_1) = \begin{array}{|c|c|} \hline 1 & 1 \\ \hline 2 & 3 \\ \hline \bar{5} & \bar{4} \\ \hline \bar{5} & \bar{2} \\ \hline \bar{4} & \\ \hline \bar{3} & \\ \hline \end{array} \Rightarrow E(T) = [\emptyset \leftarrow w(\psi(C_2)) \leftarrow w(\psi(C_1))] = \begin{array}{|c|c|c|c|} \hline 1 & 1 & 1 & 2 \\ \hline 2 & 2 & 4 & \bar{5} \\ \hline 3 & \bar{5} & \bar{4} & \bar{3} \\ \hline 5 & \bar{4} & \bar{1} & \\ \hline \bar{5} & \bar{3} & & \\ \hline \bar{4} & \bar{2} & & \\ \hline \bar{3} & & & \\ \hline \end{array}.$$

We get $E(T) \in \text{SSYT}(\lambda^A, 10)$ and one may apply to $E(T)$ any type A procedure to compute its right and left keys in $\text{SSYT}(\lambda^A, 10)$. For example, JDT procedure gives

$$(51) \quad K_+(E(T)) = \begin{array}{|c|c|c|c|} \hline 1 & 2 & 2 & 2 \\ \hline 2 & 4 & \bar{5} & \bar{5} \\ \hline 4 & \bar{5} & \bar{3} & \bar{3} \\ \hline \bar{5} & \bar{4} & \bar{1} & \\ \hline \bar{4} & \bar{3} & & \\ \hline \bar{3} & \bar{1} & & \\ \hline \bar{1} & & & \\ \hline \end{array} \quad K_-(E(T)) = \begin{array}{|c|c|c|c|} \hline 1 & 1 & 1 & 1 \\ \hline 2 & 2 & 2 & 2 \\ \hline 3 & 5 & \bar{4} & \bar{4} \\ \hline 5 & \bar{5} & \bar{3} & \\ \hline \bar{5} & \bar{4} & & \\ \hline \bar{4} & \bar{3} & & \\ \hline \bar{3} & & & \\ \hline \end{array}$$

Using Q_λ , which is uniquely determined by $\lambda = \Lambda_4 + \Lambda_3$ [4, Proposition 1, Corollary 1], to perform the reverse column Schensted insertion on $K_+(E(T))$ and $K_-(E(T))$ respectively provides the image under ψ of two pairs of KN columns C'_1, C'_2 and C''_1, C''_2 respectively. Applying ψ^{-1} to each column results in:

$$Q_\lambda = \begin{array}{|c|c|c|c|} \hline 1 & 4 & 11 & 15 \\ \hline 2 & 5 & 12 & 16 \\ \hline 3 & 6 & 13 & 17 \\ \hline 7 & 14 & 18 & \\ \hline 8 & 19 & & \\ \hline 9 & 20 & & \\ \hline 10 & & & \\ \hline \end{array} \Rightarrow \psi(C'_1) = \begin{array}{|c|c|} \hline 2 & 2 \\ \hline 4 & \bar{5} \\ \hline \bar{5} & \bar{3} \\ \hline 4 & \bar{1} \\ \hline \bar{3} & \\ \hline \bar{1} & \\ \hline \end{array}, \quad \psi(C'_2) = \begin{array}{|c|c|} \hline 1 & 2 \\ \hline 2 & \bar{5} \\ \hline 4 & \bar{3} \\ \hline \bar{5} & \\ \hline 4 & \\ \hline \bar{3} & \\ \hline \bar{1} & \\ \hline \end{array} \xrightarrow{\text{Theorem 7.10}} K_+(T) = C'_1 C'_2 = \begin{array}{|c|c|} \hline 2 & 2 \\ \hline \bar{5} & \bar{5} \\ \hline \bar{3} & \bar{3} \\ \hline \bar{1} & \\ \hline \end{array}$$

$$\Rightarrow K_+(T) = K(-1, 2, -2, 0, -2) = K(w\lambda), \text{ with } w = [2\bar{5}\bar{3}\bar{1}4] \in B_5$$

and $T \in \mathfrak{B}_w(\lambda) \subseteq \text{KN}(\lambda, 5)$.

Therefore $\mathfrak{B}_w(\lambda) \subseteq \text{KN}(\lambda, 5)$ is the set KN tableaux in $\text{KN}(\lambda, 5)$ *standard* (recall the definition in Section §3.6.4) in the symplectic Schubert variety $X_w \subseteq Sp(2n, \mathbb{C})/B$ where B is a Borel subgroup of $Sp(2n, \mathbb{C})$. Note $K^+(E(T)) = E(K^+(T)) = K(\tilde{w}\lambda^A) = K(1, 4, 0, 2, 0, 4, 2, 4, 0, 3)$, the A_{2n-1} key tableau on the LHS of (51), where $\tilde{w} = 2\bar{5}\bar{3}\bar{1}4\bar{4}13\bar{5}\bar{2} \in \mathfrak{S}_{10}$. Therefore, recalling Proposition 7.6, $E(T) \in E(\mathfrak{B}_w(\lambda)) = \mathfrak{B}_{\tilde{w}}(\lambda^A) \cap E(\text{KN}(\lambda, 5)) \subseteq \text{SSYT}(\lambda^A, 10)$, and the SSYT tableaux in $\mathfrak{B}_{\tilde{w}}(\lambda^A) \cap E\text{KN}(\lambda, 5)$ are *standard* in the Schubert variety $X_{\tilde{w}} \subseteq Gl(n, \mathbb{C})/\tilde{B}$, \tilde{B} a Borel subgroup of $Gl(n, \mathbb{C})$ such that $B = \tilde{B} \cap Sp(2n, \mathbb{C})$. (The Borel subgroups of $Sp(2n, \mathbb{C})$ are obtained by intersecting the Borel subgroups of $Gl(2n, \mathbb{C})$ with $Sp(2n, \mathbb{C})$. All Borel subgroups of G are conjugate to each other.) That is, $T \in \text{KN}(\lambda, n)$ is *standard* on the Schubert variety $X_w \subseteq Sp(2n, \mathbb{C})/B$ if and only if $E(T)$ is *standard* on the Schubert variety $X_{\tilde{w}} \subseteq Gl(n, \mathbb{C})/\tilde{B}$.

And

$$Q_\lambda \Rightarrow \psi(C''_1) = \begin{array}{|c|c|} \hline 1 & 1 \\ \hline 2 & 2 \\ \hline 5 & \bar{4} \\ \hline \bar{5} & \bar{3} \\ \hline \bar{4} & \\ \hline \bar{3} & \\ \hline \end{array}, \quad \psi(C''_2) = \begin{array}{|c|c|} \hline 1 & 2 \\ \hline 2 & 2 \\ \hline 3 & \bar{4} \\ \hline \bar{5} & \\ \hline \bar{5} & \\ \hline \bar{4} & \\ \hline \bar{3} & \\ \hline \end{array} \xrightarrow{\text{Theorem 7.10}} K^-(T) = C''_1 C''_2 = \begin{array}{|c|c|} \hline 1 & 1 \\ \hline 2 & 2 \\ \hline 4 & 4 \\ \hline \bar{3} & \\ \hline \end{array}$$

$$\Rightarrow K^-(T) = K(2, 2, -1, -2, 0) = K(\sigma\lambda), \text{ with } \sigma = [12\bar{4}\bar{3}5] \in B_5 \text{ and } T \in \mathfrak{B}^\sigma(\lambda).$$

Therefore $\mathfrak{B}^\sigma(\lambda) \subseteq \text{KN}(\lambda, 5)$ is the set KN tableaux in $\text{KN}(\lambda, 5)$ *standard* on the opposite symplectic Schubert variety $X^\sigma \subseteq Sp(2n, \mathbb{C})/B$.

Again $K^-(E(T)) = E(K^-(T)) = K(\tilde{\sigma}\lambda^A) = K(1, 4, 0, 2, 0, 4, 2, 4, 0, 3)$, the A_{2n-1} key tableau on the RHS of (51), where $\tilde{\sigma} = 2\bar{5}\bar{3}\bar{1}4\bar{4}13\bar{5}\bar{2} \in \mathfrak{S}_{10}$. Therefore, recalling Proposition 7.6, $E(T) \in E(\mathfrak{B}^\sigma(\lambda)) = \mathfrak{B}_{\tilde{\sigma}}(\lambda^A) \cap E(\text{KN}(\lambda, 5)) \subseteq \text{SSYT}(\lambda^A, 10)$, and the SSYT tableaux in $\mathfrak{B}_{\tilde{\sigma}}(\lambda^A) \cap E\text{KN}(\lambda, 5)$ are *standard* on the Schubert variety $X_{\tilde{\sigma}} \subseteq Gl(n, \mathbb{C})/\tilde{B}$, \tilde{B} a Borel subgroup of $Gl(n, \mathbb{C})$ such that $B = \tilde{B} \cap Sp(2n, \mathbb{C})$. That is, $T \in \text{KN}(\lambda, n)$ is *standard* on the Schubert variety $X_\sigma \subseteq Sp(2n, \mathbb{C})/B$ if and only if $E(T)$ is *standard* on the Schubert variety $X_{\tilde{\sigma}} \subseteq Gl(n, \mathbb{C})/\tilde{B}$.

Since $T \in \mathfrak{B}_w(\lambda)$ and $T \in \mathfrak{B}^\sigma(\lambda)$, we conclude that T is *standard* on the Richardson $X_w \cap X^\sigma$ in full flag variety $Sp(2n, \mathbb{C})/B$. More generally $\mathfrak{B}_w(\lambda) \cap \mathfrak{B}^\sigma(\lambda) \subseteq \text{KN}(\lambda, 5)$ is the set KN tableaux in $\text{KN}(\lambda, 5)$ *standard* on the symplectic Richardson variety $X_w \cap X^\sigma \subseteq Sp(2n, \mathbb{C})/B$.

Applying the SJDT procedure to T (or the direct way) provides

$$T = \begin{array}{|c|c|} \hline 1 & 2 \\ \hline 3 & \bar{5} \\ \hline \bar{4} & \bar{3} \\ \hline \bar{3} & \\ \hline \end{array} \longrightarrow \begin{array}{|c|c|} \hline 1 & 2 \\ \hline 2 & \bar{5} \\ \hline \bar{4} & \bar{3} \\ \hline & \bar{2} \\ \hline \end{array}, \quad r \begin{array}{|c|} \hline 2 \\ \hline \bar{5} \\ \hline \bar{3} \\ \hline \bar{2} \\ \hline \end{array} = \begin{array}{|c|} \hline 2 \\ \hline \bar{5} \\ \hline \bar{3} \\ \hline \bar{1} \\ \hline \end{array}, \quad \ell \begin{array}{|c|} \hline 1 \\ \hline \bar{3} \\ \hline \bar{4} \\ \hline \bar{3} \\ \hline \end{array} = \begin{array}{|c|} \hline 1 \\ \hline \bar{2} \\ \hline \bar{4} \\ \hline \bar{3} \\ \hline \end{array}$$

and we get the same output as the procedure by virtualization.

7.5.2. Baker virtualization of the crystal of Lakshmibai-Seshadri paths as B_n paths. For the dilatation of size $m = 6$, equal to the least common multiple of the maximal i -string lengths of $\text{KN}(\lambda, 3)$, $\lambda = \Lambda_2 + \Lambda_1 = (2, 1)$, we give in Figure 3 the crystal $\mathbf{B}(\Lambda)$ of L-S paths of shape $\lambda = (2, 1)$ as B_2 -paths isomorphic to $\text{KN}(\lambda, 3)$. To embed it in the crystal $\mathbf{B}(\lambda^A)$ of L-S paths of shape $\lambda^A = \Lambda_3^A + \Lambda_1^A + 2\Lambda_2^A$ as \mathfrak{S}_4 -paths, we may follow Remark 7.12. Embed, by E , $\text{KN}(\lambda, 3)$ in $\text{SSYT}(\lambda^A, 6)$ and choose M , with enough factors, in general the least common multiple of m and the i -string lengths of $\text{SSYT}(\lambda^A, 6)$, to apply the dilatation of size M to $\text{SSYT}(\lambda^A, 6)$, or dilate by M , as just defined, $\text{KN}(\lambda, 3)$ and embed it into $\text{SSYT}(M\lambda^A, 6)$ by E .

8. FINAL REMARKS

Recently a new method to compute keys was provided in [40]. Calculations on KN tableaux support evidence that this type A new method can be adapted to type KN tableaux using the split form.

9. ACKNOWLEDGEMENTS

This work was partially supported by the Centre for Mathematics of the University of Coimbra (funded by the Portuguese Government through FCT/MCTES, DOI 10.54499/UIDB/00324/2020). The second author (JMS) was supported by FCT, through the grant PD/BD/142954/2018, under POCH funds, co-financed by the European Social Fund and Portuguese National Funds from MCTES. This work has been partially conducted when the second author (JMS) was under PhD supervision by the first author (OA), and a member of the Centre for Mathematics of University of Coimbra.

The first author is grateful to Thomas Gobet, Cédric Lecouvey, Cristian Lenart, Jake Levinson, Peter Littelmann, and Travis Scrimshaw for enlightening discussions. She also thanks to Inês Rodrigues for a Latex drawing.

REFERENCES

- [1] O. Azenhas. “Schur functions, pairing of parentheses, jeu de taquin and invariant factors”. In: *Mathematical papers in honour of Eduardo Marques de Sá* Textos Mat., Série B (2006), pp. 7–24.
- [2] O. Azenhas, T. Gobet, and C. Lecouvey. “Non symmetric Cauchy kernel, crystals and last passage percolation”. In: *Tunisian Journal of Mathematics* (2023), pp. 1–35. URL: [arXiv:2212.06587](https://arxiv.org/abs/2212.06587).
- [3] O. Azenhas and R. Mamede. “Key polynomials of type C”. In: *Slides from the presentation in Séminaire Lotharingien de Combinatoire 69, Strobl*. 2012.
- [4] O. Azenhas, M. Tarighat Feller, and J. Torres. “Symplectic cacti, virtualization and Berenstein-Kirillov groups”. In: (2022), pp. 1–71. URL: [arXiv:2207.08446](https://arxiv.org/abs/2207.08446).
- [5] T. H. Baker. “Zero actions and energy functions for perfect crystals”. In: *Publ. Res. Inst. Math. Sci.* 36.4 (2000), pp. 533–572.
- [6] A. Bjorner and F. Brenti. *Combinatorics of Coxeter groups*. Vol. 231. Springer Science & Business Media, 2006.
- [7] C. Bonnaffé. *Kazhdan-Lusztig Cells with Unequal Parameters*. Springer, 2017.

- [8] M. Brion. “Lectures on the Geometry of Flag Varieties”. In: *Topics in cohomological studies of Algebraic varieties*. Birkhäuser, 2005.
- [9] B. Brubaker et al. “Colored five-vertex models and Demazure atoms”. In: *Journal of Combinatorial Theory, Series A* 178 (2021), pp. 1–48.
- [10] B. Brubaker et al. “Colored five-vertex models and Demazure atoms”. In: *J. Combinatorial Theory A* 178 (2021), pp. 1–48.
- [11] V. Buciumas and T. Scrimshaw. “Quasi-solvable lattice models for Sp_{2n} and SO_{2n+1} Demazure atoms and characters”. In: *Forum Math. Sigma* arXiv:2101.0890 ().
- [12] D. Bump and A. Schilling. *Crystal bases: representations and combinatorics*. World Scientific Publishing Company, 2017.
- [13] S.-Il Choi and J.-H. Kwon. “Lakshmibai-Seshadri paths and non-symmetric Cauchy identity”. In: *Algebras and Representation Theory* 21.6 (2018), pp. 1381–1394.
- [14] C. De Concini. “Symplectic standard tableaux”. In: *Advances in Mathematics* 34.1 (1979), pp. 1–27. DOI: 10.1016/0001-8708(79)90061-6.
- [15] A. M. Fu and A. Lascoux. “Non-symmetric Cauchy kernels for the classical groups”. In: *Journal of Combinatorial Theory, Series A* 116.4 (2009), pp. 903–917.
- [16] N. Fujita. “Schubert calculus from polyhedral parametrizations of Demazure crystals”. In: *Adv. Math.* 397 (2022), pp. 1–42.
- [17] W. Fulton. *Young tableaux: with applications to representation theory and geometry*. Vol. 35. Cambridge University Press, 1997.
- [18] T.H. Heo and J.H. Kwon. “Combinatorial Howe duality in symplectic type”. In: *Journal of Algebra* 600 (2022), pp. 1–44. DOI: 10.1016/j.jalgebra.2022.01.037. URL: arXiv:2008.05093.
- [19] P. Hersh and C. Lenart. “From the weak Bruhat order to crystal posets”. In: *Mathematische Zeitschrift* 286 (2017), 1435–1464. DOI: 10.1007/s00209-016-1808-5.
- [20] N. Jacon and C. Lecouvey. “Keys and Demazure crystals for Kac–Moody algebras”. In: *Journal of Combinatorial Algebra* 4.4 (2020), pp. 325–358.
- [21] M. Kashiwara. *Bases cristallines des groupes quantiques*. Vol. 9. Cours spécialisés de la Soc. Math. de France, 2002. URL: <https://www.kurims.kyoto-u.ac.jp/~kenkyubu/kashiwara/sd2002.pdf>.
- [22] M. Kashiwara. “Crystal bases and Littelmann’s refined Demazure character formula”. In: *Duke Math. J.* 71.3 (1993), pp. 839–858.
- [23] M. Kashiwara. “Global crystal bases of quantum groups”. In: *Duke Math. J.* 69.2 (1993), pp. 455–485. DOI: 10.1215/S0012-7094-93-06920-7.
- [24] M. Kashiwara. *On crystal bases, Representations of groups (Banff, AB), CMS Conf. Proc.* Vol. 16. Amer. Math. Soc., Providence, RI, 1994, pp. 155–197.
- [25] M. Kashiwara. “Similarity of Crystal Bases”. In: *Lie Algebras and Their Representations, Contemporary Mathematics*. Vol. 194. Amer. Math. Soc., Providence, RI, 1996, pp. 177–186.
- [26] M. Kashiwara and T. Nakashima. “Crystal Graphs for Representations of the q -Analogue of Classical Lie Algebras”. In: *Journal of Algebra* 165 (1994), pp. 295–345. DOI: 10.1006/jabr.1994.1114.
- [27] R. C. King. “Weight multiplicities for the classical groups”. In: *Group theoretical methods in physics*. Springer, 1976, pp. 490–499.
- [28] J.-H. Kwon. “Crystal Graphs and the Combinatorics of Young Tableaux”. In: *Handbook of Algebra*. Vol. 6. North-Holland, 2009, pp. 473–504. DOI: 10.1016/S1570-7954(08)00208-8.
- [29] V. Lakshmibai and P. Littelmann. “Richardson varieties and equivariant K -theory”. In: *J. Algebra* 260 (2003), pp. 230–260. DOI: 10.1016/S0021-8693(02)00634-8.

- [30] V. Lakshmibai, C. Musili, and C. S. Seshadri. “Geometry of G/P ”. In: *Bull. Amer. Math. Soc. (N.S.)* 1.2 (1979), 432–435.
- [31] V. Lakshmibai and K. Raghavan. *Standard Monomial Theory*. Vol. 137. Springer, Enciclopedia of Mathematical Sciences, 2008.
- [32] A. Lascoux. “Double crystal graphs”. In: *Studies in memory of Issai Schur*. Springer, 2003, pp. 95–114.
- [33] A. Lascoux and M.-P. Schützenberger. “Keys and standard bases”. In: *Invariant theory and tableaux* 19 (1990), pp. 125–144.
- [34] C. Lecouvey. “Schensted-type correspondence, plactic monoid, and jeu de taquin for type C_n ”. In: *Journal of Algebra* 247.2 (2002), pp. 295–331.
- [35] C. Lenart. “A Unified Approach to Combinatorial Formulas for Schubert Polynomials”. In: *Journal of Algebraic Combinatorics* 20 (2004), 263–299.
- [36] C. Lenart and A. Lubovsky. “A generalization of the alcove model and its applications”. In: *Journal of Algebraic Combinatorics* 41.3 (2015), pp. 751–783.
- [37] P. Littelmann. “A Littlewood-Richardson rule for symmetrizable Kac-Moody algebras”. In: *Invent Math* 116 (1994), 329–346. DOI: 10.1007/BF01231564.
- [38] P. Littelmann. “Crystal graphs and Young tableaux”. In: *Journal of Algebra* 175.1 (1995), pp. 65–87.
- [39] G. Lusztig. “Canonical bases arising from quantized enveloping algebras”. In: *J. Am. Math. Soc* 3.2 (1990), pp. 447–498.
- [40] K. N. Raghavan M. S. Kushwaha and S. Viswanath. “Simple Procedures for Left and Right Keys of semi-standard Young tableaux”. In: *arXiv:2302.08279* (2023), pp. 1–17.
- [41] S Mason. “A decomposition of Schur functions and an analogue of the Robinson–Schensted–Knuth algorithm”. In: *Séminaire Lotharingien de Combinatoire* 57 (2008), B57e.
- [42] S. Mason. “An explicit construction of type A Demazure atoms”. In: *Journal of Algebraic Combinatorics* 29 (2007), pp. 295–313.
- [43] V. Reiner and M. Shimozono. “Straightening for Standard Monomials on Schubert varieties”. In: *Journal of Algebra* 195.1 (1997), pp. 130–140. DOI: 10.1006/jabr.1997.7092.
- [44] J. M. Santos. “Symplectic keys and Demazure atoms in type C”. In: *Séminaire Lotharingien de Combinatoire - FPSAC 2020* 84B (2020), pp. 1–12.
- [45] J. M. Santos. “Symplectic keys and Demazure atoms in type C”. In: *Electronic Journal of Combinatorics* 28 (2021), pp. 1–33. DOI: 10.37236/9235.
- [46] J. M. Santos. *Symplectic Keys and Demazure Atoms in type C*. Thesis (Ph.D.)University of Coimbra, 2022. URL: <https://estudogeral.uc.pt/bitstream/10316/105080/3/thesis.pdf>.
- [47] J. M. Santos. “Symplectic Right Keys - Type C Willis’ direct way”. In: *Séminaire Lotharingien de Combinatoire - FPSAC 2021* 85B (2021), pp. 1–12.
- [48] J. Sheats. “A symplectic jeu de taquin bijection between the tableaux of King and of De Concini”. In: *Transactions of the American Mathematical Society* 351.9 (1999), pp. 3569–3607.
- [49] David E Speyer. “Richardson varieties, projected Richardson varieties and positroid varieties”. In: *arXiv:2303.04831* (2023), pp. 1–62.
- [50] R. Stembridge. “Rational tableaux and the tensor algebra of gl_n ”. In: *J. Combin. Theory Ser. A* (1987). DOI: 10.1016/0097-3165(87)90077-X.
- [51] M. Willis. “A Direct Way to Find the Right Key of a Semistandard Young Tableau”. In: *Annals of Combinatorics* 17 (2011), pp. 393–400.
- [52] A. Woo and A. Yong. “Schubert geometry and combinatorics”. In: *arXiv:2303.01436* (2023), pp. 1–58.

UNIVERSITY OF COIMBRA, DEPARTMENT OF MATHEMATICS, CMUC, 3000-143 COIMBRA, PORTUGAL
Email address: ozenhas@mat.uc.pt
Email address: jmsantos@mat.uc.pt

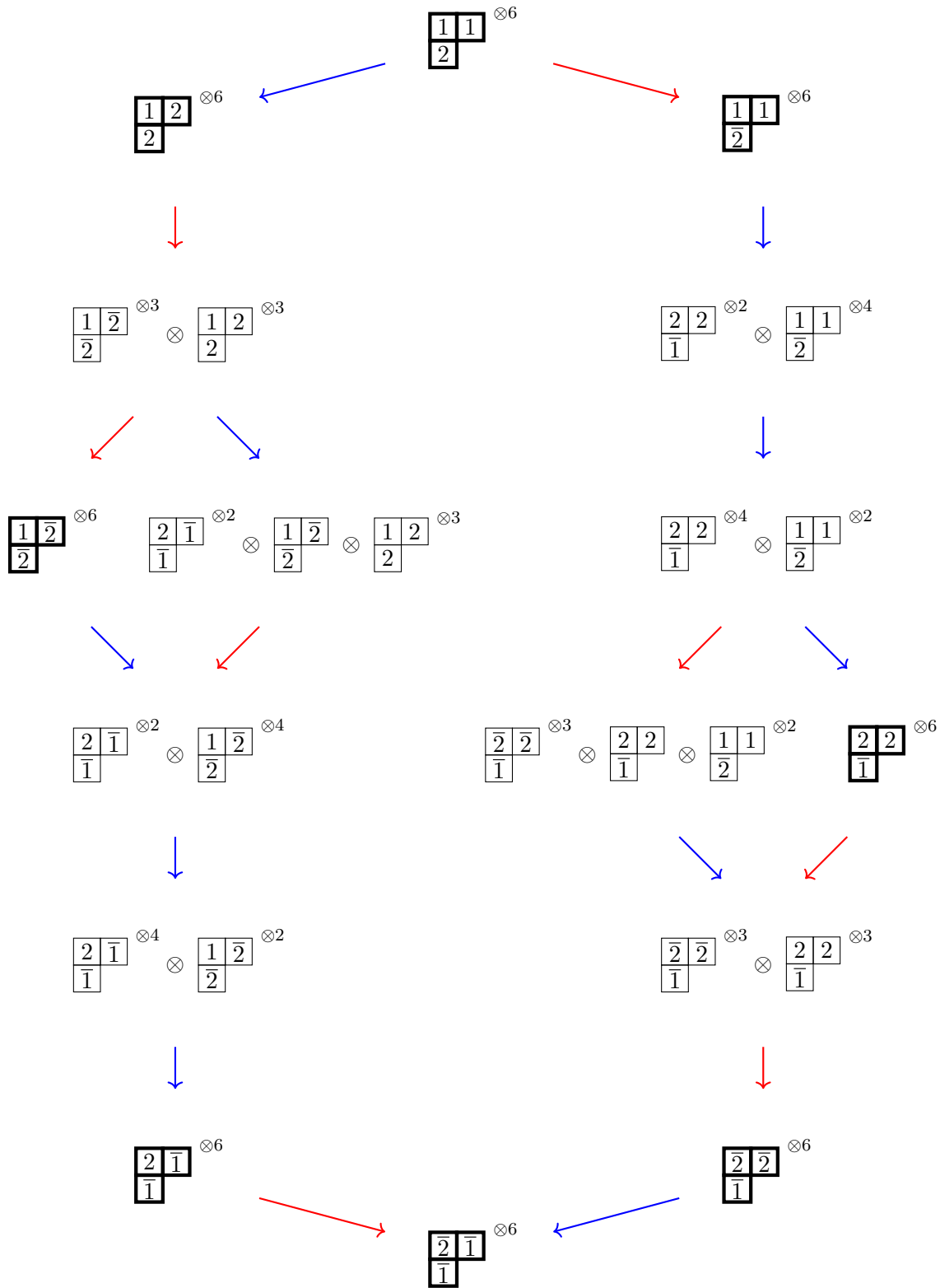

FIGURE 2. The dilatation of the crystal $\text{KN}((2,1),2)$ in Figure 1, by $m = 6$, the least common multiple of the maximal i -string lengths, inside $\text{KN}((12,6),2) \simeq \mathfrak{B}(K(2,1)^{\otimes 6}, 2)$, exhibiting the right and left keys of each vertex of $\text{KN}((2,1),2)$ as the leftmost respectively rightmost factor in each 6-fold tensor product of keys in $O_{B_2}(2,1)$. The blue (resp. red) arrow means f_1^6 (resp. f_2^6).

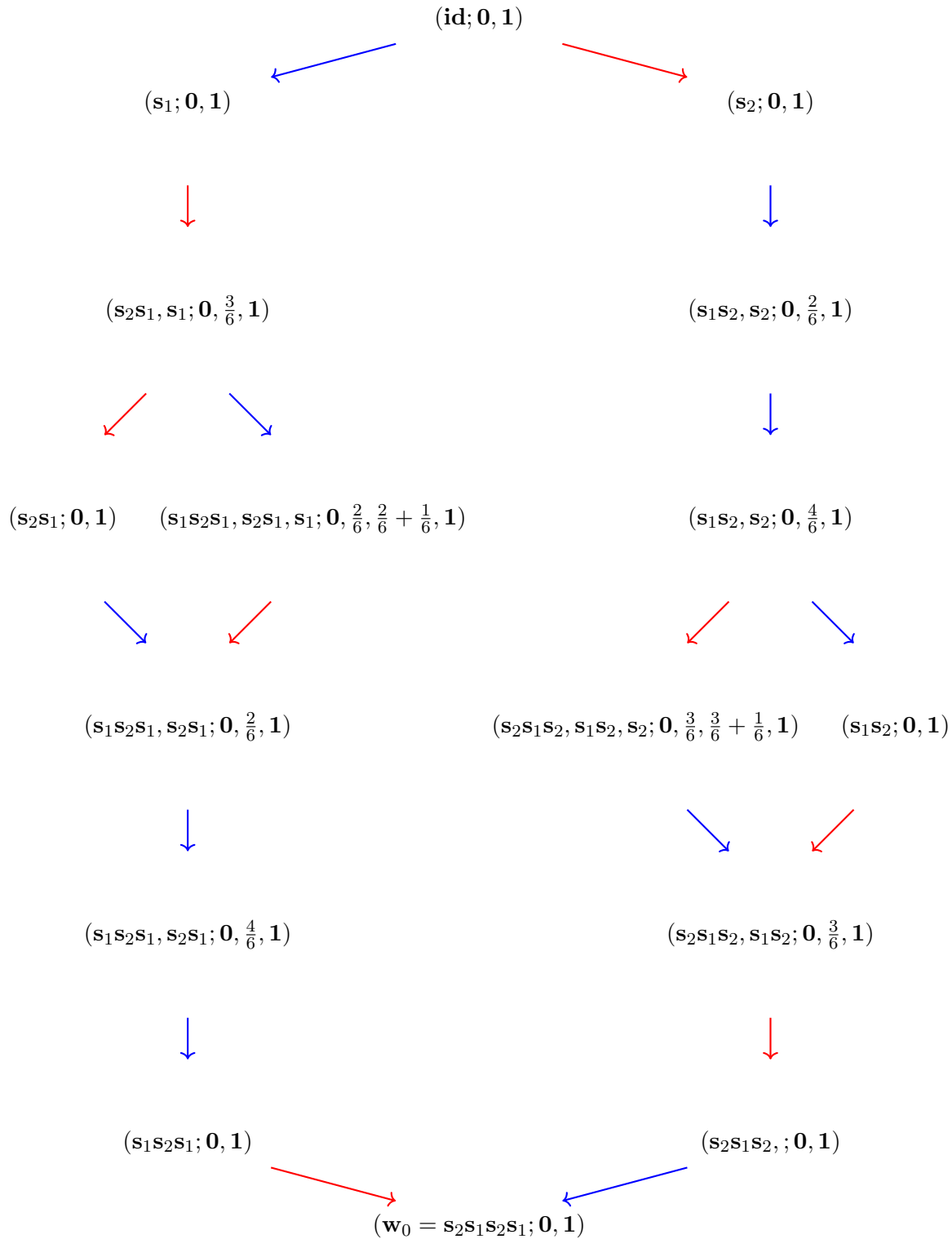
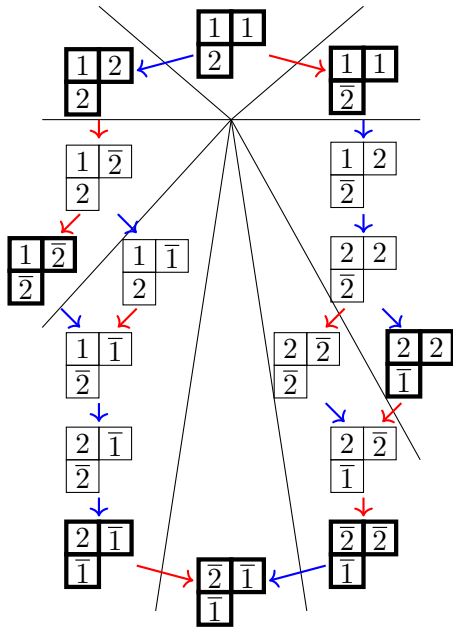

FIGURE 3. The crystal $\mathbf{B}(2, 1)$ of L-S paths of shape $\lambda = \Lambda_2 + \Lambda_1 = (2, 1)$ obtained from the dilatation of the C_2 crystal $\mathfrak{B}(2, 1)$. The C_2 Weyl group $B_2 = \langle s_1, s_2 \mid s_1^2 = s_2^2 = 1, (s_1s_2)^4 = 1 \rangle$ with long element $\mathbf{w}_0 = s_2s_1s_2s_1$.



The crystal is split into $|B_2(2, 1)| = 8$ parts, the number of elements of the B_2 -orbit of $(2, 1)$. Each part is a Demazure crystal atom and contains exactly one symplectic key tableau in $O(\lambda)$, drawn with thick lines, so we can identify each part with the weight of that key tableau, which is a vector in the B_2 -orbit of $(2, 1)$.

FIGURE 4. The partition of the C_2 crystal graph $\mathfrak{B}(2, 1)$ into $|B_2(2, 1)| = 8$ Demazure atom crystals .

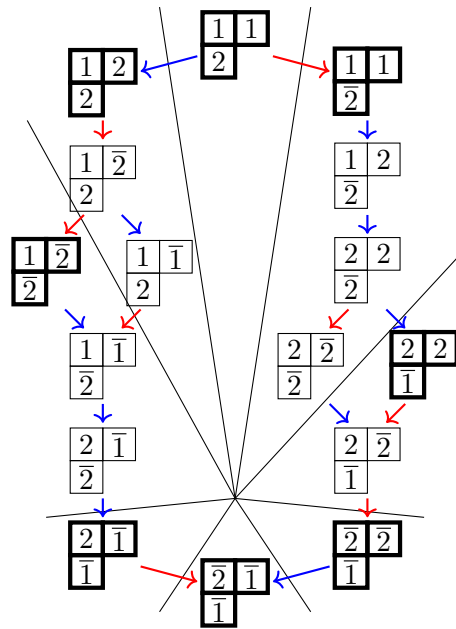

FIGURE 5. The C_2 crystal graph $\mathfrak{B}(2, 1)$ split into opposite Demazure crystal atoms.

Type A_2 crystals $\mathcal{SSYT}((3, 3, 1), 3)$

$\mathfrak{B}^{\lambda'}(T)$

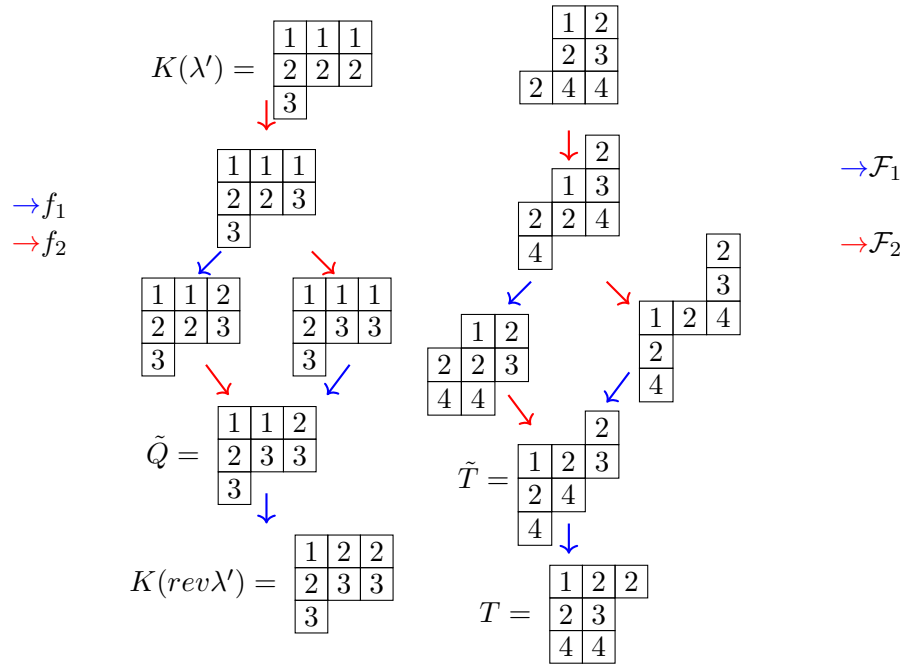

FIGURE 6. The type A_2 crystal operators f_1 and f_2 are given by the signature rule on the alphabet $[3]$, whereas \mathcal{F}_1 and \mathcal{F}_2 , even though they are also type A_2 crystal operators, are defined by elementary SJDT moves.

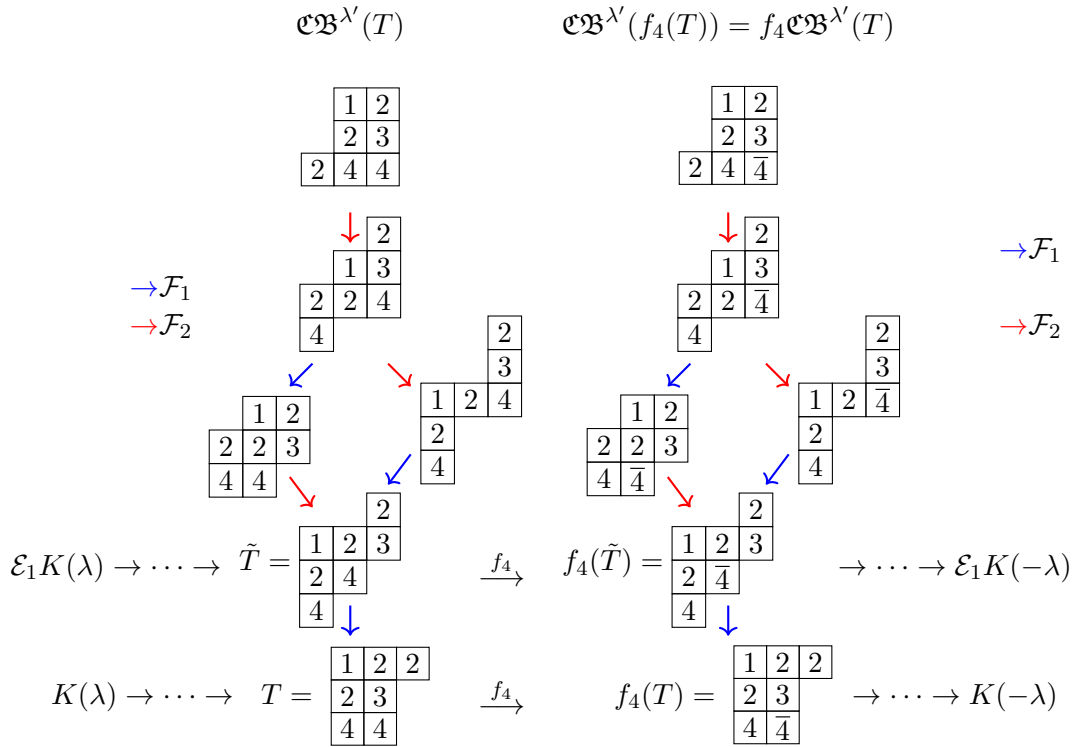

FIGURE 7. The vertical array of isomorphic cocrystals attached to T and $f_4(T)$ in $\mathcal{KN}((3, 3, 2), 4)$ respectively. The (horizontal) array of (isomorphic) C_4 symplectic crystals generated by elementary SJDT moves on each vertex of $\mathcal{KN}((3, 3, 2), 4)$.